



CEMB
BALANCING MACHINES

Via Risorgimento, 9
23826 – Mandello del Lario (LC) – ITALY
www.cemb.com



N130

PORTABLE EQUIPMENT
USER MANUAL



تجهیز انرژی باختر

TAJHIZ ENERGY BAKHTAR

Chapter 1 - General description

➤ Standar accessories.....	1 – 1
➤ Optional accessories	1 – 2
➤ Connections	1 – 3
➤ Input A (vibration sensor – BLUE input)	1 – 4
➤ Input Tacho (photocell sensor – YELLOW input)	1 – 4
➤ Status LEDs.....	1 – 4
➤ Battery	1 – 5
➤ General advice	1 – 5

Chapter 2 - General layout

➤ Keys/buttons on the control panel.....	2 – 1
➤ ON/OFF button.....	2 – 1
➤ OK button.....	2 – 2
➤ Function keys	2 – 2
➤ Arrow keys	2 – 2
➤ Screen description	2 – 3
➤ General purpose functions	2 – 3
➤ Functions associated with the measuring phase	2 – 3
➤ Function “Save measure”	2 – 4
➤ Function “Open measure”	2 – 5
➤ Function “Measure setup”	2 – 6
➤ Function “Take screenshot”	2 – 7
➤ Function operating on the graphs (valid only for FFT function)	2 – 8
➤ Scale setting	2 – 8
➤ Use of the cursor.....	2 – 8
➤ Peak list.....	2 – 9

Chapter 3 - Home screen (menu)

Chapter 4 - Setup mode

➤ Sensor setup.....	4 – 1
➤ Sensor type.....	4 – 1
➤ Sensor sensitivity.....	4 – 2
➤ Measure setup	4 – 2
➤ Measurement unit.....	4 – 3
➤ Unit mode.....	4 – 3
➤ Frequency unit.....	4 – 3
➤ Max frequency.....	4 – 4
➤ Number of lines.....	4 – 4
➤ High pass frequency	4 – 5
➤ Number of averages	4 – 5
➤ Device setup.....	4 – 6
➤ Date / Time.....	4 – 6
➤ Language	4 – 7
➤ LCD backlight.....	4 – 7
➤ Device info.....	4 – 7
➤ Firmware upgrade.....	4 – 8

Chapter 5 - Vibrometer mode

➤ Vibrometer (OVERALL measure) – measurement screen.....	5 – 1
➤ Vibrometer 1xRPM (filtered measure) – measurement screen.....	5 – 1
➤ Measurement of an OVERALL vibration.....	5 – 2
➤ Measurement of a 1xRPM vibration.....	5 – 2
➤ MENU function.....	5 – 3
➤ Save measure.....	5 – 3
➤ Open measure	5 – 3
➤ Measure setup.....	5 – 3
➤ 1xRPM	5 – 3
➤ Take screenshot.....	5 – 3

Chapter 6 - FFT mode - Fast Fourier Transform

➤ Spectral analysis (FFT) – measurement screen	6 – 1
➤ Measurement of a FFT spectra	6 – 2
➤ Management of the X-Y axis of the graph.....	6 – 2
➤ MENU function.....	6 – 3
➤ Cursor mark.....	6 – 3
➤ Peak list	6 – 4
➤ Save measure	6 – 4

➤ Open measure.....	6 – 4
➤ Measure setup	6 – 4
➤ Autoscale.....	6 – 4
➤ Take screenshot	6 – 5

Chapter 7 - “Smart Analysis” mode

➤ “Smart Analysis” – measurement screen	7 – 1
➤ Setting the type of machine to be analyzed	7 – 1
➤ Setting the rotation speed detection mode	7 – 3
➤ Photocell	7 – 3
➤ Manual entry.....	7 – 4
➤ Auto detection	7 – 4
➤ Detection of a “Smart Analysis” measure.....	7 – 5
➤ MENU function	7 – 6
➤ Save measure	7 – 6
➤ Open measure.....	7 – 6
➤ Change machine setup.....	7 – 6
➤ Change speed detection setup.....	7 – 6
➤ Take screenshot.....	7 – 6

Chapter 8 - “CBA” mode

➤ “CBA” – measure screen	8 – 2
➤ Measurement of a “CBA” value	8 – 2
➤ MENU function	8 – 2
➤ Save measure	8 – 3
➤ Open measure.....	8 – 3
➤ Take screenshot	8 – 3

Chapter 9 - “TACHO” mode

➤ “TACHO” – measurement screen	9 – 1
➤ Measurement of a “TACHO” value	9 – 2
➤ MENU function	9 – 2
➤ Take screenshot	9 – 2

Appendix A - Technical data

Appendix B - Evaluation criteria

Appendix C - A rapid guide to interpreting a spectrum

Appendix D - Photocell for instruments Nx30

Appendix E - The JSON format



تجهیز انرژی باختر

TAJHIZ ENERGY BAKHTAR



General description







The **N130** instrument is supplied, together with its accessories, in a special case. It is advisable, each time the instrument is used, to place back it in its case in order to avoid risk of damage during transit.



TAJHIZ ENERGY BAKHTAR

Standard accessories:

	DESCRIPTION
	No. 1 accelerometer transducer 100mV/g
	No.1 connection cable, length 2 meters, for accelerometer
	No.1 magnetic base \varnothing 25 mm

	No.1 probe
	No.1 micro USB cable
	No.1 battery charger with multiplug adapters
	No.1 HEAVY DUTY carrying case
	No.1 USB key containing instruction manual in PDF format
	"Quick Guide" brochure with basic operations for use

Optional accessories:

DESCRIZIONE	
	Connection cable, length 5 meters, for accelerometer
	Extension cable, length 10 metres, for transducer/photocell
	Photocell complete with stand and magnetic base
	Roll of reflecting paper

Connections



1. battery charger
2. micro USB port (useful for connecting the instrument to a PC and sharing a folder for the exchange of data between the two elements)
3. connector for photocell input
4. connector for senso input

To connect the sensor or the photocell, insert the connector (type M12 male) into the corresponding socket, screwing it clockwise until it is locked, as shown in the figure below.



To extract the connector, instead, unscrew anticlockwise until it is completely extracted.

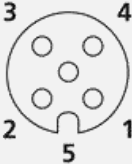

Input A (vibration sensor – BLUE input)

CONNECTOR	PINOUT
	1 – GROUND + SHIELDING (SIG-) 2 – SENSOR INPUT (SIG+) 3 – SENSOR POWER SUPPLY

Input TACHO (photocell sensor – YELLOW input)

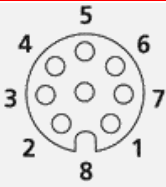
CONNECTOR	PINOUT
	1 – +24 VDC 5 – TACHO IN 8 – GROUND + SHIELDING

Status LEDs







The keypad panel includes a LED, positioned between the display and the keyboard. The operating principle is as follows:

LED COLOR	LED STATUS	DESCRIPTION
ORANGE	Slow flashing	The instrument is acquiring the measure
GREEN	Steady	Battery charging in progress
RED	Steady	Battery flat
	Fast flashing	Battery almost flat
GREEN/ORANGE	Slow flashing	The instrument is acquiring the measure with battery charger connected

Battery

The N130 instrument is provided with a built-in rechargeable lithium battery, which allows autonomy of more than 8 hours under normal operating conditions of the instrument. The battery status is indicated by an icon in the upper right hand corner of the screen.

BATTERY INDICATOR	DESCRIPTION
	Battery fully charged
	Battery partly charged
	battery almost flat (battery life remaining when this appears is approx. 2 hours)
	Battery flat: recharge within 45 minutes
	Battery in charge

Caution:



It is strongly recommended to recharge the battery with the instrument switched off: as recharging is completed within less than 4 hours such precaution prevents the battery charger from being connected for an excessively long period of time (max. 12 hours).

Caution:



The lithium battery is able to withstand the recharging-discharging cycles, even on a daily basis, without problems but it could become damaged if allowed to be fully discharged. For this reason it is advisable to recharge the battery at least once every three months, even in the case of extended idle period.

Note:



When the battery is being charged, the status LED will be steady green (see **Status LEDs 1-4**). When the battery is charged, the LED will switch off.

General advice

Keep and use the instrument far from sources of heat and strong electromagnetic fields (inverters and high-power electric motors).

Measurement accuracy could be impaired by the connection cable between the transducer and instrument, therefore it is recommended to:

- not allow such cable to have sections in common with power cables;
- prefer a perpendicular arrangement when overlapping power cables;
- always use the shortest possible length of cable; in fact floating lines would act as active or passive antennae.



تجهیز انرژی باختر

TAJHIZ ENERGY BAKHTAR

General layout

Keys/buttons on the control panel



The control panel of the CEMB N130 instrument incorporates a keypad where the various keys or buttons can be subdivided by function:

ON/OFF button



Press this button to switch the instrument on; hold it down for at least 3 seconds to switch it off, then release the button.

Note:



After pressing , the instrument is ready for use only at the end of the switching on procedure, signaled by the appearance of the home screen (see Chap. 3).

Note:



After the instrument has been switched off, about 5 seconds must pass before it can be switched back on again.



Caution:

In case the instrument no longer responds to any command, it can be turned off by keeping the button  pressed for about 12 seconds.

OK button



Pressing this button in a setup screen confirms the settings selected, and allows switching to the next screen. In a menu frame, the selected item is confirmed, while in a measuring screen it has the function of start/stop the measurement (see **2-3 Start / Stop acquisition**).

Function keys



The F1 and F2 keys are at the top of the keypad, below the display. In the various screens they can perform different functions, indicated in the boxes at the bottom of the display, directly above these two buttons.

Arrow keys







Allow to move within the items of the instrument main menu and the menu of each individual function.



Viewing an FFT chart, they allow the zoom of X axis (, ) and Y axis (, ).



In the Setup screens, they allow the choice of the parameter to be modified (, ), the parameter chosen they allow to decree the configuration values (, ).

Screen description



1. battery charge level (see 1-5 Battery)
2. measure/function type
3. date and time
4. main screen content - graphical representation of the measurement
5. information/indications on the measure
6. function corresponding to the F1 key
7. function corresponding to the F2 key
8. F2 key
9. F1 key

TAJHIZ ENERGY BAKHTAR

General purpose functions

In addition to many functions, specific for each different purpose and described in relative sections, there are certain general purpose functions which are described below.

- **Functions associated with the measuring phase**

Start / stop acquisition:

In all the Measurement screens, acquisition is started by pressing **OK** , and is subsequently stopped by again pressing **OK** .

The active acquisition status is easily to recognize by the presence of a status LED, which is orange flashing slow (v. 1-4 Battery).

- **Function “Save measure”**

Available where is possible to save an acquired data. In this phase the instrument shows the available projects; the data saving cases can be 2:

1. **Saving in a existing project**

Select the project name from the list and press **OK**.

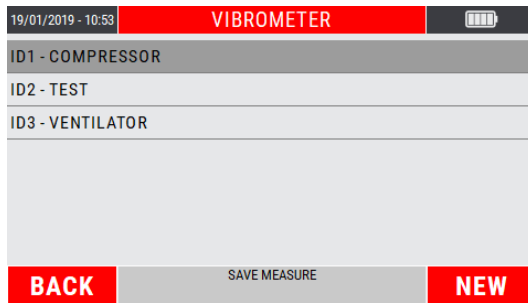

Select the bearing support number (selectable value from 1 to 20), then the orthogonal measurement direction. Use the **←** and **→** keys to make choices and press **OK** to confirm.

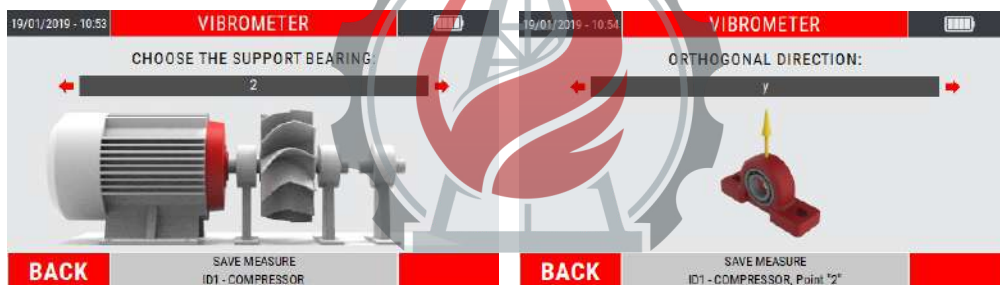

2. **Saving in a new project**



In the saving screen press **F2** (NEW).

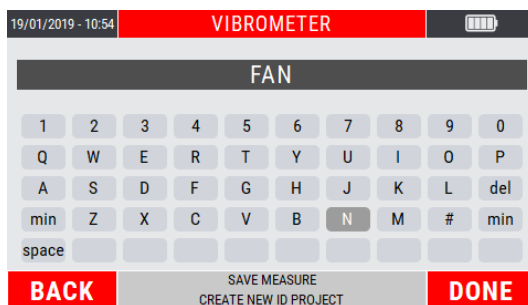

Type the desired name for the project; each single letter that composes the name must be selected by moving with the "arrow" keys on the keypad visible on the display and confirming the choice by pressing **OK**. Key **F2** (DONE) to confirm the project name.

Continue to save the data as reported in point 1.

The successful saving of the measurement is confirmed by the following screen.

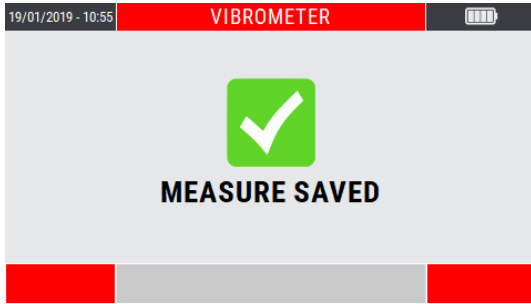

Note:

Use “arrow” keys and **OK** to confirm.



Note:

For the type of the reserved data and its management refer to **Appendix E - "The JSON file"**

- **Function “Open measure”**

Available in different functions of the instrument.

If activated by the key **F2** (MENU) of a specific function, it makes visible the saved data related to that type of measurement.

Press **F2** (MENU) and select the project of interest:

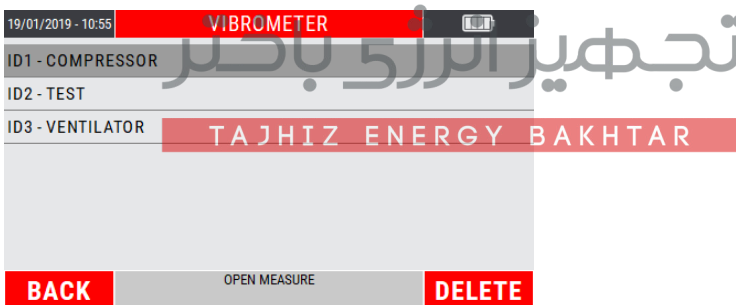

Inside, select the measuring point (bearing support number) and the orthogonal direction among those available.

Finally select the measure of interest saved within the measurement point.

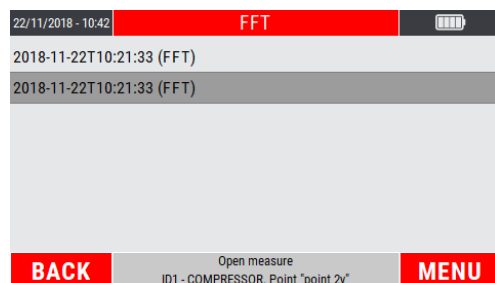
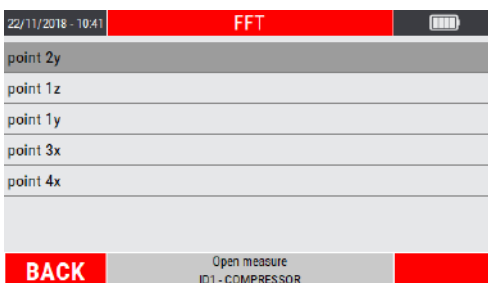

Once the measurement point has been selected, press **OK** to display the saved date on the display.

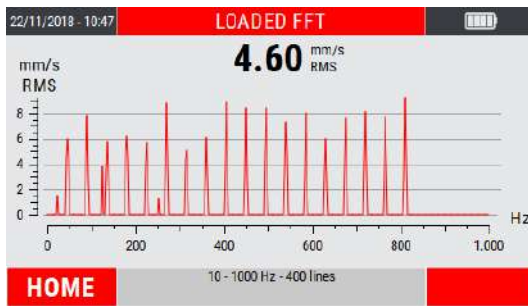

Note:

Use “arrow” keys and **OK** to confirm.



Note:

For the type of the reserved data and its management refer to **Appendix E - "The JSON file"**

- **Function “Measure setup”**

Available in different functions of the instrument.

If activated by **F2** key (MENU) of a specific function, it allows direct access to the modification of the measurement setups (see **Measure Setup 4-2**).

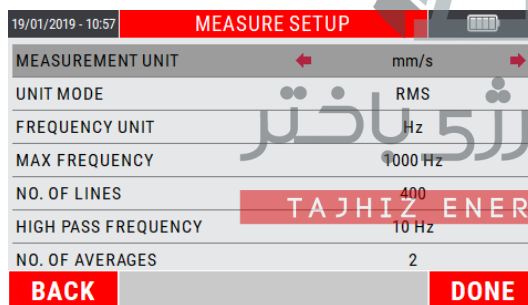

Use keys and to select the parameter to be modified, with keys and select the value to be set.

Press **F2** (DONE) to confirm and exit from the SETUP panel.



Note:

When **F2** (DONE) is pressed, the display returns to the screen from which the SETUP function has been accessed.



Note:

The changes made on the SETUP screen will be applied to all those functionalities subject to common SETUP.



Note:

By pressing the  key (BACK) the changes made are canceled and the previous setup is restored

- **Function “Take screenshot”**

Function available in all the MENU items that allow to "capture" the display screenshot by saving it as a ".png" file.



Once the screen is "captured", the display will show confirmation that it has been saved.



Press  to return to the measure screen.







Note:

The ".png" files will be saved in the instrument's internal memory – "N130/archive/screenshots/" path.

Functions operating on the graphs (valid only for FFT function)

- **Scale setting:**

After an acquisition, the data is displayed on the graph in AUTOSCALE mode (axes limits in line with the data in the graph).

The zoom of the X axis is possible by pressing the “arrow” keys  and , while keys  and  make the zoom of the Y axis.

Pressing  (MENU) and selecting AUTOSCALE, the axis limits are set again in line with the data in the graph.

Note:



The measure can be started even with  after zooming one or both axes, but the stop of the measurement automatically causes the AUTOSCALE of the graph.

- **Use of the cursor:**



In any graph can be introduced a cursor, so as to facilitate the reading and interpretation of the data displayed.

With data acquired data press  (MENU); then select the item "SHOW CURSOR" using the keys  and .

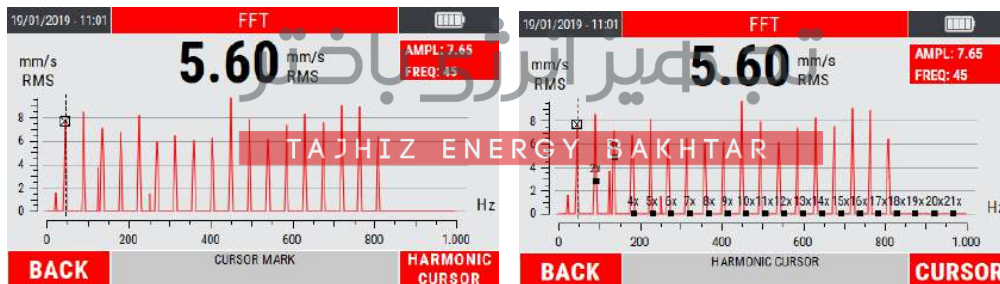
Press  to confirm.



The cursor can be moved one step to the right or left using the keys  or .

The key  (HARMONIC CURSOR) shows on the graph up to 50 harmonics of the main peak highlighted by the cursor. Press  (SINGLE CURSOR) to return to the highlighted cursor only.

Select  (BACK) to delete the cursor from the graph.

Note:



The measure can be started with  even while the cursor is visible; during and at the end of the measure the cursor disappears.

- **Peak list:**

When this function is selected, a table appears with the 10 peaks of highest value present in the zone of the spectrum displayed, and associated with the corresponding frequencies.

AMPLITUDE [mm/s RMS]	FREQUENCY [Hz]
7.8795	46.1125
8.7035	90.25
7.2615	136
6.8495	181.1
8.343	225.125
6.077	270.212

BACK Peak List

Their value is calculated by applying an interpolation algorithm to the FFT graph; this also allows identifying peaks not situated in correspondence to one of the lines of the spectrum (see **Measure setup – Number of lines 4-5**).

When is **F1** (BACK) pressed, the system quits this function and again displays the graph (or graphs).

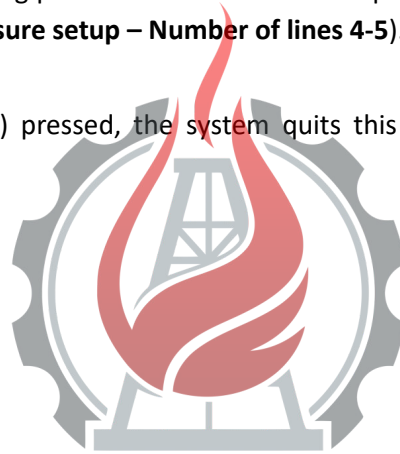

تجهیز انرژی باختر

TAJHIZ ENERGY BAKHTAR



تجهیز انرژی باختر

TAJHIZ ENERGY BAKHTAR

Home screen (menu)

After fully switching on the N130 instrument, it shows its Home screen.









which, besides showing a set of information as:

- current date and time
- battery charge state

تجهیز انرژی باکhtar
TAJHIZ ENERGY BAKHTAR

as a normal menu, it also proposes and allows selection of the available functionality, namely:

ICON	NAME	DESCRIPTION
	SETUP	<ul style="list-style-type: none"> ▪ setting of the sensors connected to the instrument ▪ setting of the general measurement parameters ▪ setting of the general operating parameters of the instrument
	LOAD MEASURE	<ul style="list-style-type: none"> ▪ data management (load or delete the data saved on instrument N130)
	VIBROMETER	<ul style="list-style-type: none"> ▪ measurement of the total value and synchronous measurement of vibration
	FFT (Fast Fourier Transform)	<ul style="list-style-type: none"> ▪ splitting of the vibration into its component frequencies ▪ display of waveform of the vibration

ICON	NAME	DESCRIPTION
	SMART ANALYSIS	<ul style="list-style-type: none"> measurement of the overall vibration amplitude with the fixed frequency range of 10÷1000 Hz and measurements performed in mm / s RMS evaluation of the analyzed machine according to the ISO 10816-3 parameters diagnosis on the causes of vibrations
	CBA (CEMB Bearing Analysis)	<ul style="list-style-type: none"> evaluation of the bearing condition
	TACHO	<ul style="list-style-type: none"> measurement of the rotation speed of a impeller (by using the photocell - optional for N130)



تجهیز انرژی باختر

TAJHIZ ENERGY BAKHTAR

Setup mode

This mode allows to make all the settings configuration possible on the N130 instrument.

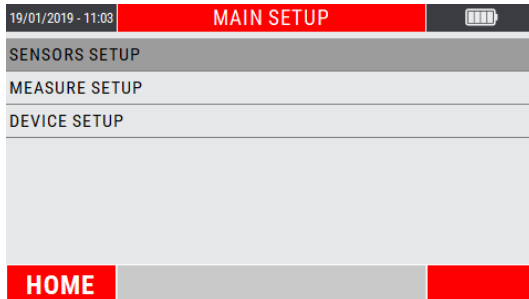

These setting are:

1. setting of the sensors connected to the instrument
2. setting of the general measurement parameters
3. setting of the general operating parameters of the instrument

Sensor setup

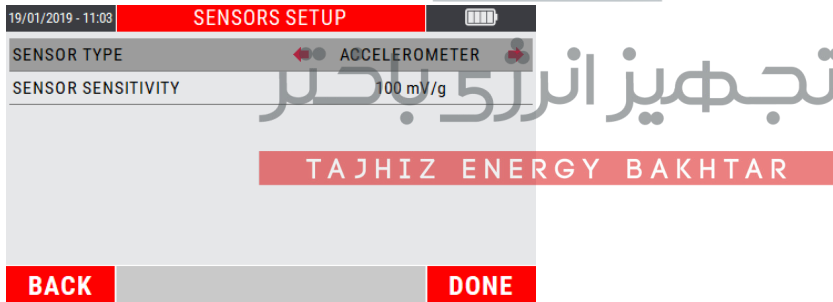

The N130 instrument can be used only with **IEPE** sensors. L'apparecchio può essere utilizzato solo con sensori **IEPE**, both Accelerometer and Velomitor type.



- **Sensor type:**

Any one of the following possibilities can be selected:



- **ACCELEROMETER**
- **VELOMITOR**

Use the keys  and  to make the choice. Pressing the key  (DONE) will confirm the setting and return to the instrument HOME page.

- **Sensor sensitivity**



This is the number of volts per unit produced by the sensor: it is expressed for the various types in

SENSOR TYPE	SENSITIVITY	TYPICAL VALUE
ACCELEROMETER	mV/g	100
VELOMITOR	mV/(mm/s)	3,94

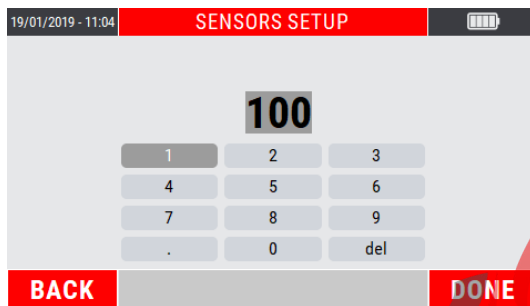
Use the keys  and  to access to the sensitivity value setup page.



Use the "arrows" keys to enter the correct numerical value; every single digit must be confirmed using the key .

Pressing the key  (DONE) will confirm the setting and return to the SENSOR SETUP page. Pressing the key  (DONE) again returns to the HOME page of the instrument.

Caution:



Different models can have sensitivity differing from the typical values; pay attention when taking the correct value from the sensor documentation and preset it.

TAJHIZ ENERGY BAKHTAR

Measure setup

This page allows to set the parameters with which the vibration measurement will be carried out.

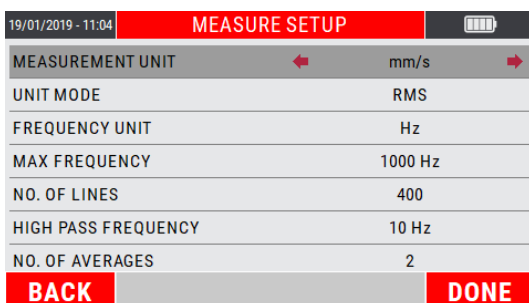

- **Measurement unit**

Select the unit of measurement in which to supply the vibration; possibilities are as follows:

- acceleration (g) – *this unit enhances the higher frequencies and attenuates the low frequencies*
- velocity (mm/s or inch/s)
- displacement (μm or mils) – *this unit enhances the lower frequencies and attenuates the high frequencies*

- **Unit mode**

It is the mode in which vibration is provided, and it can be:

- **RMS (Root Mean Square)**
 - this is the average value of the vibration previously squared;
 - this is the typically used value by the european standards, above all, for acceleration or speed measurements;
 - it is a direct index of the "energetic" content of the vibration: it represents the power that the vibration brings with itself, which is discharged on the supports or the supports of the vibrating structure.
- **PK (Peak):**
 - this is the maximum value reached by the vibration in a certain interval of time;
 - it is calculated by multiplying the RMS value by 1.41.
- **PP (Peak-to-Peak):**
 - this is the difference between maximum value and minimum value reached by the vibration in a certain period of time;
 - it is calculated by multiplying the RMS value by 2.82;
 - it is normally used for measuring displacement.

- **Frequency unit**

The choice can be:

- Hz - cycles (revolutions) per second
- cpm - cycles per minute



Note:

Between the two units there is evidently the relation $1\text{Hz} = 60\text{cpm}$

- **Max frequency**

This is the maximum frequency of interest in the phenomenon under examination; it is the maximum frequency that can be displayed in the spectrum.

It can be chosen among the default values 1000, 2500, 5000, 10000 Hz.



Note:

The typical choice, suitable for most situations, is 1000 Hz (60,000 RPM), coherently with the requirements of *ISO 10816-3*.



Note:

One practical consideration normally adopted is that of making sure that the max. frequency preset is at least 20-30 times that of the frequency of rotation of the shaft being examined. This allows including in the spectrum also the high frequency zone where problems relating to the bearings usually occur.

- **Number of lines**

Such parameter defines the number of lines used in the FFT algorithm, in practice associated with the resolution in frequency in the spectrum. This determines how close can be the frequency of two peaks so that they still remain distinct in the FFT graph. Such resolution is equal to

$$\frac{f_{max}}{N_{linee}}$$

therefore to maintain it constant, when the max. frequency is increased, likewise the number of lines should be increased.

It is useful to remember that the time required for acquisition of the correct number of samples is exactly equal to the inverse of the resolution; then the time required for data processing should be added to this time. An example of the relation between resolution- acquisition time may be derived from the following table:

Resolution [Hz]	t _{acquisition} [sec]
5	0,2
2,5	0,4
1,25	0,8
0,625	1,6
0,3125	3,2

Note:



The use of an excessively high number of lines is not recommended unless in situations where an extreme resolution is essential. In fact, such choice would lead to an increase in calculation times and space required for data saving, often without adding particular information.

A reasonable choice would be 200, 400 or max. 800 lines, being careful to set a max. frequency coherent with the situation in question.

- **High pass frequency**

If enabled, it is the minimum frequency of interest in the phenomenon under investigation; it is the minimum frequency that can be displayed in the spectrum. It can be selected among the default values OFF, 10, 20, 50, 100, 200 Hz.

If not enabled (OFF) the minimum frequency that can be displayed will be twice the resolution.

- **Number of averages**

This is the number of spectra/data which should be calculated and averaged between each other to increase stability of the measurement. Four averages are more than sufficient for normal vibration measurements on rotating machines. The default values are OFF, 10, 20, 50, 100, 200 Hz.

Note:







Greater will be the number of averages and greater will be the time necessary to process the measurement.

تجهیز انرژی باکhtar
TAJHIZ ENERGY BAKHTAR

Note:



For all the sub-menus available in MEASURE SETUP, use the keys  and  to select the items to be changed. Use  and  to set the desired parameter.

Pressing the key  (DONE) will confirm the settings and return to the HOME page of the instrument.

Device setup

The parameters for general use of the instrument should be preset in this page.

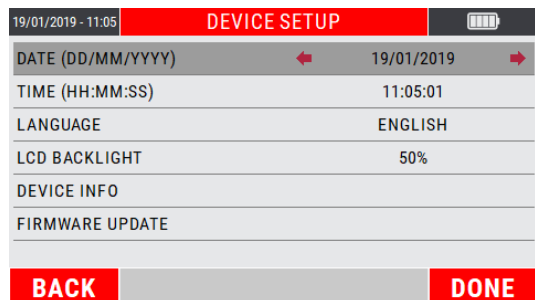

- **Date / Time**

Use the keys or to enable parameter modification.

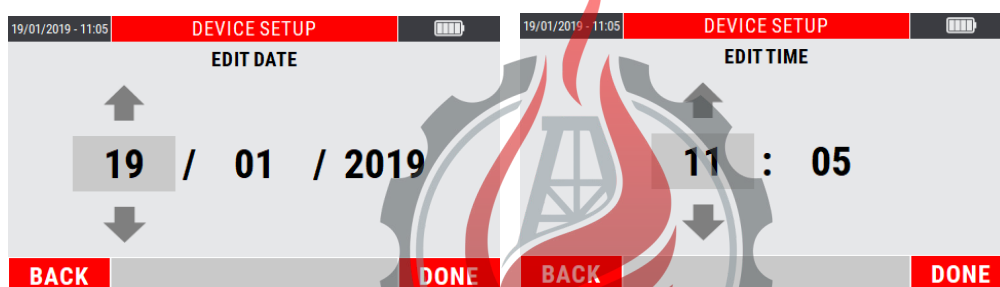

Then use the keys or to set the date in the format DD/MM/YYYY or the time in the format HH: MM.



Note:

With regard to the date setup, the item YEAR (YYYY) can be adjusted within the limits 2018 ÷ 2100.



Note:

Press (DONE) to confirm the entered values. Pressing again (DONE) confirms the setting and returns to the HOME page of the instrument.

Pressing (BACK) exits the setup page without any validated modification.

- **Language**

Select one of the possible languages:

- ITALIAN
- ENGLISH
- GERMAN
- SPANISH
- FRENCH
- CHINESE
- RUSSIAN

- **LCD backlight**

Adjusts the display backlighting from a minimum value (10%) to a maximum (100%), with intermediate steps of 10%.

- **Device info**

Allows only the viewing of information on the instrument, namely:

- GUID
- FIRMWARE RELEASE
- OS RELEASE
- BOOTLOADER RELEASE
- BATTERY
- CPU TEMPERATURE



تجهیز انرژی باختر

TAJHIZ ENERGY BAKHTAR

• Firmware update

It allows updating the firmware installed in the device, in case this is necessary.

Each new version of the firmware consists of a file with extension *.blq*.

To complete the update, proceed as follows:

- Connect the N130 to the PC with the supplied USB cable
- Copy the new firmware into the update folder on the N130
- Disconnect the USB cable
- Select "Firmware update" in the N130 device
- Press OK
- Wait for the end of operation, which may take a few minutes

Caution:



Before upgrading, make sure the battery is fully charged. If the device is unloaded during a firmware update, the process fails and the device may be unusable making necessary a shipment to CEMB for assistance and repair.

Caution:



During the update, the device will automatically restart one or more times. Wait for the end of operation without intervening.

Caution:



The firmware update is a delicate operation, and must be performed by carefully following the instructions provided, so as not to cause malfunctions or data loss, using only *firmware* obtained directly from CEMB assistance.

Caution:



In the event that the automatic update operation is not successful, contact CEMB assistance, reporting the type of error reported.

TAJHIZ ENERGY BAKHTAR

Note:



Press the "arrows" keys to make selections.

Pressing  (DONE) confirms the settings set.

Vibrometer mode

One of the simplest, but at the same time most significant information in vibration analysis, is the overall value of the actual vibration. In fact, this is very often the first parameter to be considered when evaluating the operating conditions of a motor, fan, pump, machine tool. Appropriate tables allow discrimination between an optimum state and a good state, or from an allowable, tolerable, non-permissible or even a dangerous one. (see **Appendix B – Evaluation criteria**).

In certain situations instead, it could be interesting to know the values of modulus and phase of the synchronous vibration (1xRPM), i.e. corresponding to the speed of rotation of the rotor. The vibrometer mode is designed to make this type of measure.

Vibrometer (OVERALL measure) – measurement screen

The measurement page supplies a series of information, organized as shown in the figure:

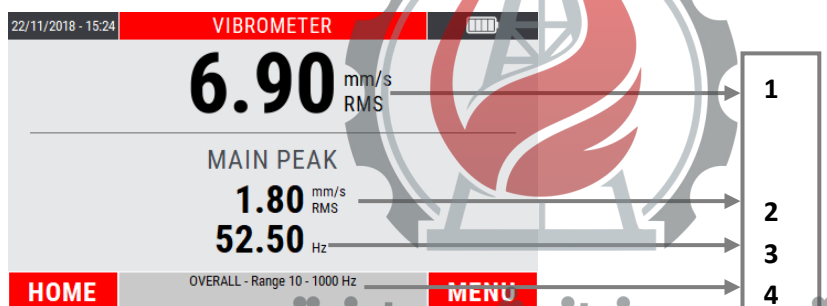

1. overall vibration value
2. amplitude value of the main peak that makes up the frequency spectrum
3. characteristic frequency of the main peak in amplitude
4. information on the frequency range in use (see **Max frequency 4-4**)

Vibrometer 1xRPM (filtered measure) – measurement screen

The measurement page supplies a series of information, organized as shown in the figure:

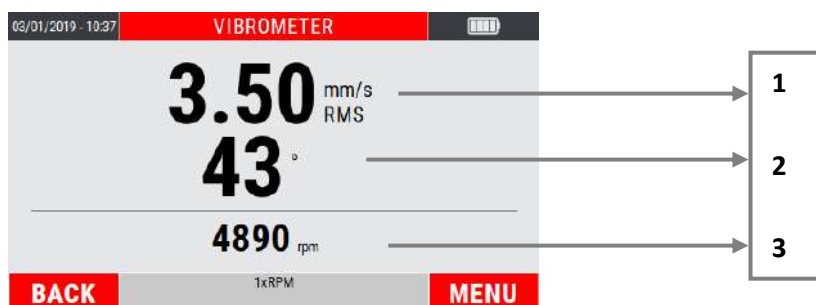

1. 1xRPM amplitude of the vibration
2. angular phase of the 1xRPM vibration
3. impeller rotation speed

Measurement of an OVERALL vibration

Select the VIBROMETER mode from the main page of the instrument by pressing the key **OK**.

At the first access to the function after switching on the instrument, if no measurement has been performed yet, an alarm reminds to connect the sensors before making the measurement.



Press **OK** to start the measurement; the instrument acquires continuously, press again **OK** to freeze the acquisition.

Measurement of a 1xRPM vibration

Within the VIBROMETER mode, access to the menu using the key **F2** (MENU) and select the 1xRPM item. Confirm by pressing **OK**.



At the first access to the function after switching on the instrument, if no measurement with sensor and photocell has been performed yet, an alarm reminds to connect the sensors before making the measurement.

Press **OK** to start the measurement; the instrument acquires continuously, press again **OK** to freeze the acquisition.

Note:



The measurement of a 1xRPM vibration requires the use of the photocell; therefore a reflecting plate must be applied on the impeller as a reference mark (0°). Starting from this position, the angles are measured in the opposite direction to the shaft rotation (see **appendix D - Photocell for Nx30 instruments**).

MENU function

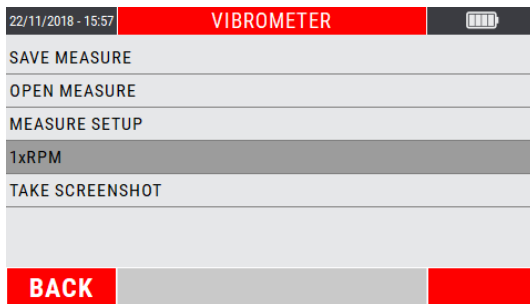

Access to the menu using the key . The following functionalities are available here:

- **Save measure**

Allows the data saving in a determined project of the detected measurement (see **Function "Save measure" 2-4**).

- **Open measure**

Allows the opening of a certain measure previously acquired through the VIBROMETER mode and saved in a specific project (see **Function "Open measure" 2-5**).

- **Measure setup**

Allows modification of the measure setup (see **Setup mode 4-1**).

- **1xRPM**

Allows to switch to 1xRPM synchronous vibration measurement. When the active measurement is the latter, the menu command returns to MEASURE OVERALL (see **"Measurement of a 1xRPM vibration" 5-2**).

- **Take Screenshot**

Allows to "capture" the image on the screen by saving it as a .png file (see **Function "Take screenshot" 2-7**).



تجهیز انرژی باختر

TAJHIZ ENERGY BAKHTAR

FFT mode - Fast Fourier Transform

A complete analysis of the vibration cannot fail to take into account the study of the various factors contributing towards forming its overall value. Hence it is essential to be able to carry out spectrum analysis with FFT (Fast Fourier Transform) algorithm.

Such technique allows splitting and memorizing a measured signal into its component frequencies in a certain period of time, thus making it easier to discover their causes.

Analysis of the highest peaks in the spectrum, together with analysis of the frequencies to which they correspond allows determining which are the principle sources of vibration and, therefore, the aspects on which to act in order to reduce them.

Although a spectrum contains a series of very significant information, its interpretation requires a certain amount of experience and attention; for this purpose, the material given in **Appendix C – A rapid guide to interpreting a spectrum could be useful.**

Spectral analysis (FFT) – measurement screen

The measurement page has the aspect shown in the figure, and is organized in such a way as to maximize the area dedicated to the representation of the FFT chart as much as possible.

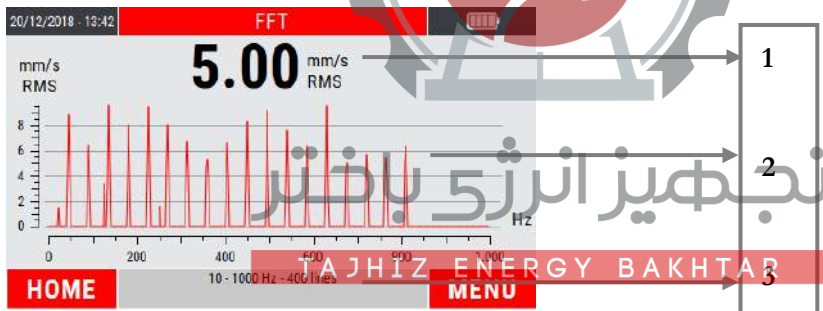

1. overall vibration value
2. area of representation of the graph
3. information on the frequency range in use (see **Max frequency 4-4**)

Note:



The measurement unit, the unit mode and the frequency range is set by the SETUP mode (see **Setup mode 4-1**), freely modifiable via function mode or the menu command.)

Note:



The overall vibration value will be the same measurable by the VIBROMETER mode. The vision of this value allows to keep the overall vibration under control, even during the analysis of its individual components.

Measurement of a FFT spectra

Select the FFT mode from the main page of the instrument by pressing the key .

At the first access to the function after switching on the instrument, if no measurement has been performed yet, an alarm reminds to connect the sensors before making the measurement.

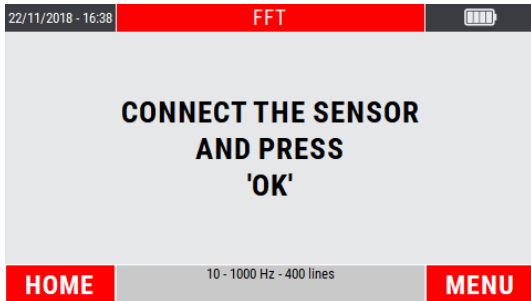

Press  to start the measurement; the instrument acquires continuously, press again  to freeze the acquisition.

Management of the X-Y axis of the graph

After the measurement, the data is plotted on the graph in AUTOSCALE mode (axis limits in line with the data in the graph).

The zoom of the X axis can be managed by pressing the keys  and , while the keys  and  determine the zoom of the Y axis (see **Scaling 2-8**).

Note:



The measurement can be started pressing  even after zooming one or both axes; stopping the measurement automatically causes the AUTOSCALE of the graph.

Note:



After managing the X/Y axes by zooming, by accessing the MENU of the function (pressing the key ) and selecting AUTOSCALE, the axis limits are set again in line with the data in the graph.

MENU function

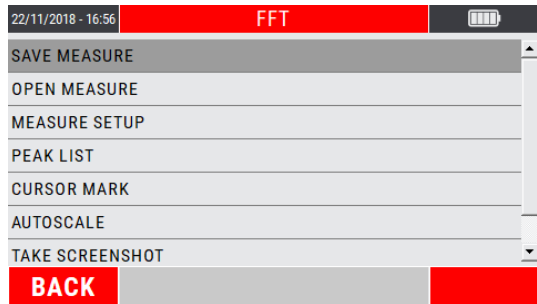

Access to the menu using the key **F2**. The following functionalities are available here:

- **Cursor mark**

Displaying the cursor on an FFT chart (see **Use of the cursor 2-8**) makes available a particular mode called *Harmonic Cursor*.

Within the FFT function, access to the MENU by pressing **F2**; select the item CURSOR confirming with **OK**.

As a result the cursor automatically positions itself on the peak with greater amplitude.

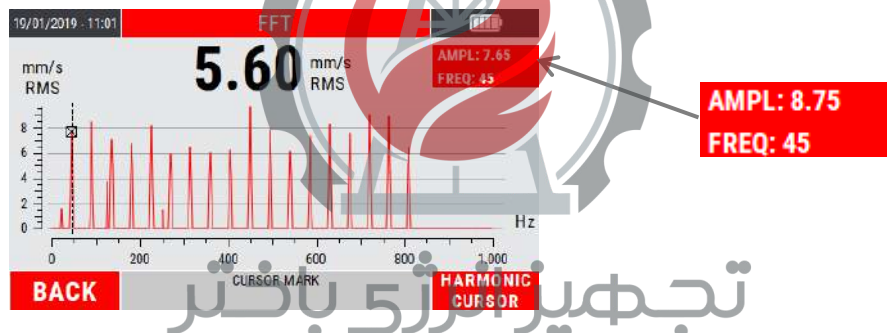



A box in the upper right corner indicates the amplitude and frequency values of the peak highlighted by the cursor.

Using the keys **←** and **→** move the cursor to another peak in a frequency of interest. Moving the cursor will automatically update the box containing the amplitude and frequency information of the highlighted peak.

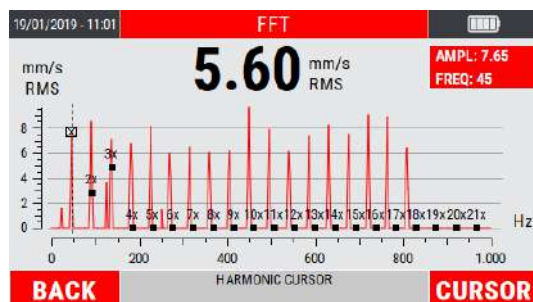
Pressing the key **F2** activates the HARMONIC CURSORS mode: the graph shows all the harmonics of the upper order (2nd, 3rd, 4th, ... up to 50th) of the highlighted peak.



The keys  and , which determines the movement of the dominant cursor on the various frequency peaks, consequently determines the movement of the corresponding harmonic cursors.

Note:



The harmonic cursor allows to easily recognize in the spectrum families of peaks in correspondence of multiple frequencies, typically indicative of particular defects (see **Appendix C**).



- **Peak list**

This MENU item shows a table with a maximum of 10 peaks of higher amplitude, associated to the corresponding frequency (see **List peaks 2-9**).

19/01/2019 - 11:01 FFT	
AMPLITUDE [mm/s RMS]	FREQUENCY [Hz]
7.8795	46.1125
8.7035	90.25
7.2615	136
6.8495	181.1
8.343	225.125
6.077	270.212

BACK Peak List

The peaks value is calculated by applying an interpolation algorithm to the graph, and this allows to identify the exact value of the frequency of the individual peaks regardless of the number of lines selected.

Within the FFT mode, access the MENU by pressing . Select the item PEAK LIST confirming by .

- **Save measure**

Allows the data saving in a determined project of the detected measurement (see **Function "Save measure" 2-4**).

- **Open measure**

Allows the opening of a certain measure previously acquired through the VIBROMETER mode and saved in a specific project (see **Function "Open measure" 2-5**).

- **Measure setup**

Allows modification of the measure setup (see **Setup mode 4-1**).

- **Autoscale**

Reset the axis limits in accordance with the graph data (see **Scale Setting 2-8**).

- **Take Screenshot**

Allows to "capture" the image on the screen by saving it as a *.png* file (see **Function "Take screenshot" 2-7**).





تجهیز انرژی باختر

TAJHIZ ENERGY BAKHTAR

“Smart Analysis” mode

This functionality should be considered as a simple and fast method for the evaluation of vibrations on standard type rotating machines.

The function, according to the international standard ISO 10816-3 (*Evaluation of machine vibration by measurements on non-rotating parts*), measures the velocity of vibration expressed in mm/s RMS and within the frequency range 10÷1000 Hz.

In addition to the numerical value indicating the amplitude of vibration, it provides a measurement judgment (again according to ISO 10816-3 (see **Appendix B**)) and an indication of the main causes that determine the vibration detected.



Caution:

The measure is limited within the frequency range 10÷1000 Hz. It follows that, on the operating side, can be evaluated machines with a maximum rotation frequency corresponding to **60000 RPM**.

“Smart Analysis” – measurement screen

The measurement page supplies a series of information, organized as shown in the figure:

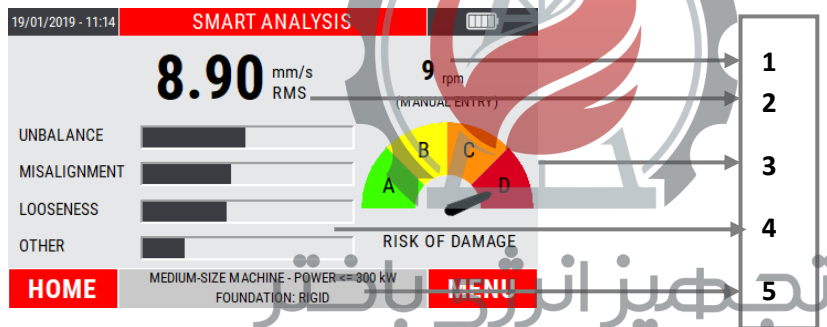

1. value and method of detection of the rotation speed
2. overall vibration value
3. vibration judgment indicator (according to ISO 10816-3)
4. information on the main components of vibration
5. characteristics of the machine under analysis

Setting the type of machine to be analyzed

Select the SMART ANALYSIS mode from the main page of the instrument by pressing the key



At the first access to the function after switching on the instrument, a setup procedure is accessed.

- **STEP 1:** setting of the type industrial machine and its installed power

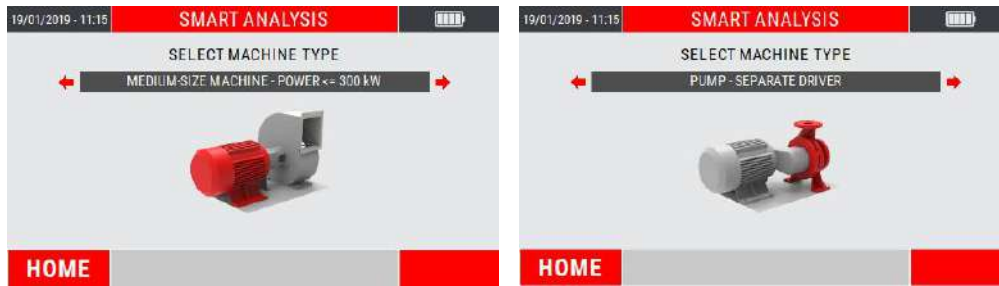

Select from the following possibilities:

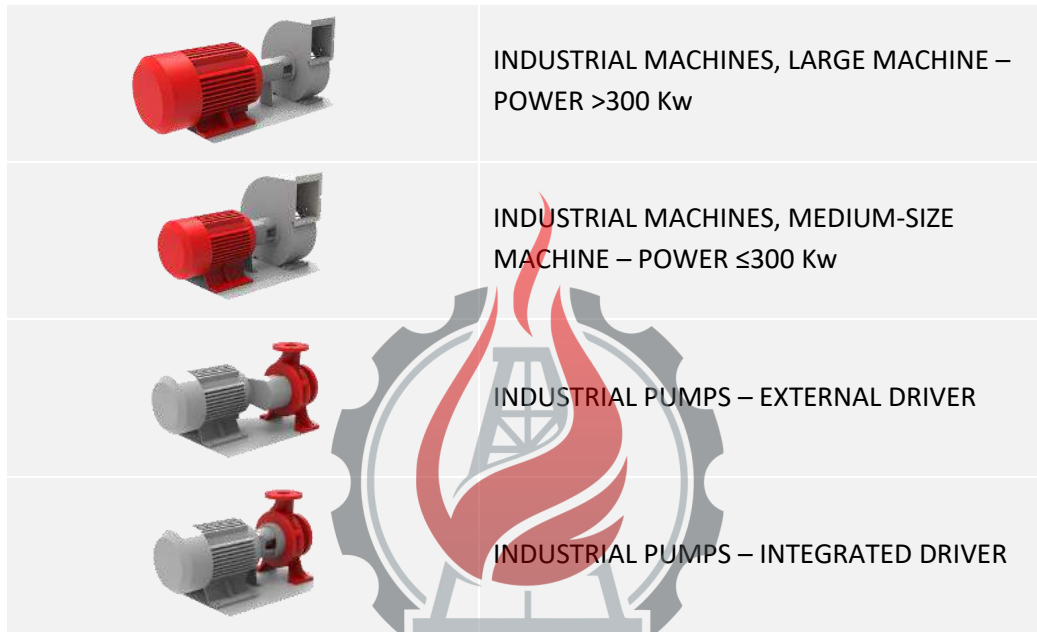

- **STEP 2:** setting the foundation type

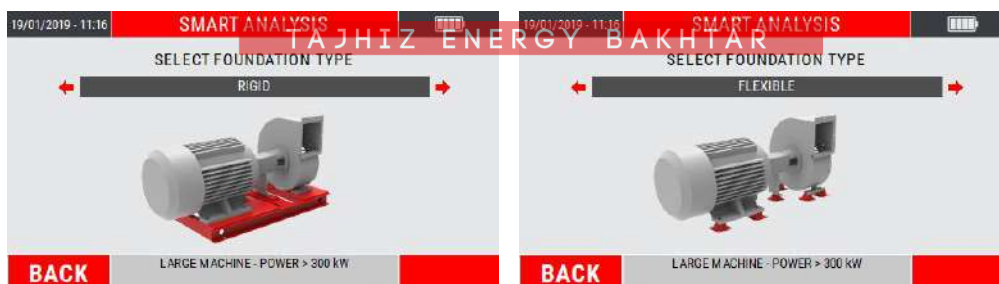

Select from the following possibilities:

- RIGID
- FLEXIBLE

Note:



Move between the choices available using the keys and .

Confirm each setup step using the key .

Return to the previous step using (BACK).

Note:



This setup is set only when the function is first accessed. By exiting and accessing it again the previously setup is retained.
To change it, refer to the CHANGING MACHINE SETTINGS item available in the function MENU.

Setting the rotation speed detection mode

The mode of detection of the rotation speed of the impeller (necessary to diagnose the causes of vibration) is requested.

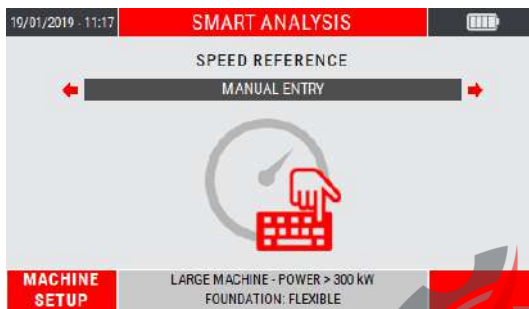

Select from the following possibilities:

- PHOTOCCELL
 - MANUAL ENTRY
 - AUTO DETECTION
- **Photocell**

The rotation speed is acquired through the use of the photocell sensor (optional for N130 instrument).

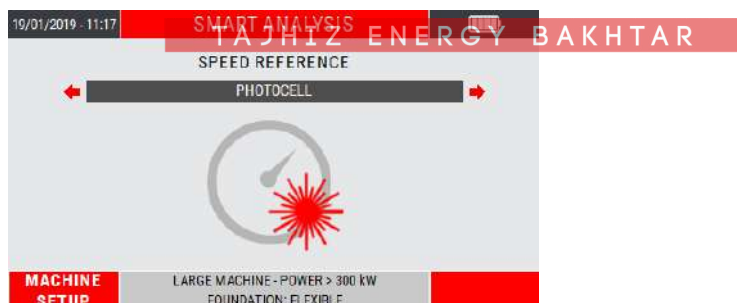

Note:



The use of the photocell needs to applying a reflecting plate on the impeler as a reference mark (see **appendix D - Photocell for CEMB Nx30 instruments**).

- **Manual entry**

The rotation speed data is entered manually.

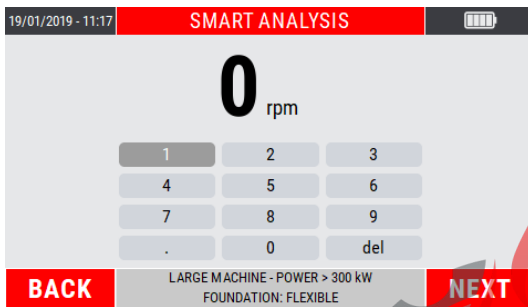
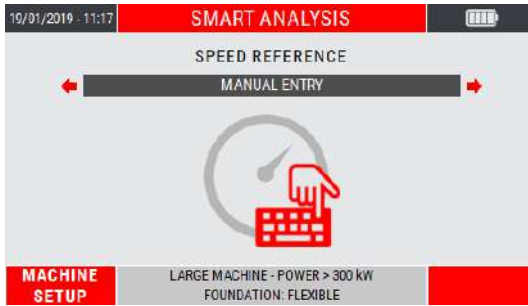

Move in the numeric keypad using the “arrows keys”. Confirm each individual digit by pressing **OK**. At the end of the procedure press **F2** (NEXT) to confirm.



Note:

Check the rotation speed by consulting the plate data or the operating manual of the machine under analysis.

- **Auto detection**

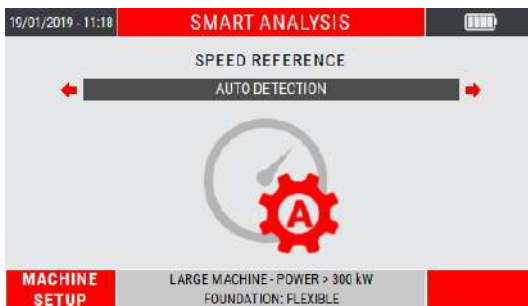

The rotation speed data is acquired by the user's choice of one of the dominant peaks available in the frequency spectrum.



Choosing this speed detection method, the instrument is ready to acquire a vibration signal.

Press the key **OK** to start/stop the measurement. A list is proposed containing the frequencies of the first 3 dominating peaks in amplitude.

19/01/2019 - 11:18 SMART ANALYSIS	
FREQUENCY [cpm]	
2721	
5446.5	
8115.75	
BACK	DETECTING ROTATION SPEED



Select the peak of interest with the keys  or  ; press  to confirm.

Note:



This setup is set only when the function is first accessed. By exiting and accessing it again the previously setup is retained.
To change it, refer to the item CHANGE SPEED DETECTION SETUP available in the function MENU.

Detection of a "Smart Analysis" measure

After the setups shown on the previous pages or after having accessed the function again, press  to start the measurement; the instrument acquires continuously, press  to freeze the acquisition.

When the measurement is acquired, the key  (HOME) returns to the HOME page of the instrument, while the key  (MENU) leads to the function MENU.

Note:



As for the other instrument measure functions, only and only at the first detection (of this type) after switching on the instrument, an alarm reminds to connect the sensors before making the measurement.

MENU function

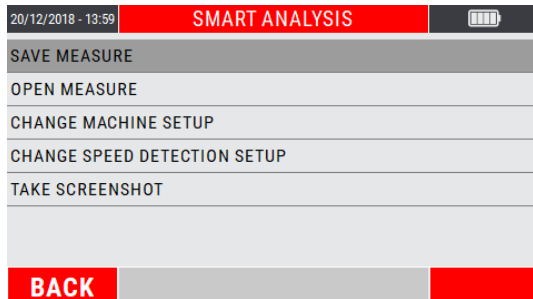

Access to the menu using the key . The following functionalities are available here:

- **Save measure**

Allows the data saving in a determined project of the detected measurement (see **Function "Save measure" 2-4**).

- **Open measure**

Allows the opening of a certain measure previously acquired through the SMART ANALYSIS mode and saved in a specific project (see **Function "Open measure" 2-5**).

- **Change machine setup**

Allows to modify the setup of the machine under analysis (see **Function "Setting the type of machine to be analyzed" 7-1**).

- **Change speed detection setup**

Allows to modify the setup on how to measure the rotation frequency (see **Function "Setting the rotation speed detection mode" 7-3**).

- **Take Screenshot**

Allows to "capture" the image on the screen by saving it as a *.png* file (see **Function "Take screenshot" 2-7**).

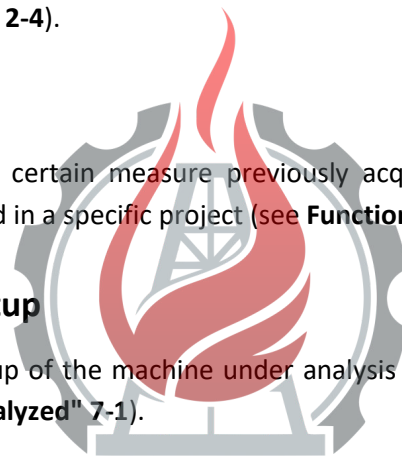

تجهیز انرژی باکhtar
TAJHIZ ENERGY BAKHTAR

“CBA” mode

Rolling bearing, widely used in rotating machines, has a low vibration energy amplitude in case of damage

For this reason it is difficult understand the real bearing condition with a standard analysis in velocity unit and planning a correct predictive maintenance program.

First output of a damaged rolling bearing are impact metal to metal at the fundamental frequencies of the four elements (cage, ball, inner race and outer race).

Any impact produce a signal at high frequency, connected to the natural bearing resonance.

A correct way to measure bearing condition is the envelope of the acceleration signal acquired in a high frequency range.

CEMB SpA develope this CBA function (*CEMB BEARING ANALYSIS*), measured in gE (acceleration g calculate with an envelope algorithm).

Note:



It is not possible define an unique value for evaluation of bearing condition, because it depend on many factors: bearing support dimension, rotation speed, power and load condition, etc.

Note:



The correct way is to monitor the value during time and evaluate the change compared to a reference value (first acquisition or after a bearing maintenance).

If possible the vibration measurements being compared shall be taken at the same transducer location and orientation and under approximately the same machine operating conditions.

TAJHIZ ENERGY BAKHTAR

Note:



Because the CBA function measure in a high frequency range, the sensor mounting should be as rigid as possible, ensuring that mounting procedure does not influence the measured value.

The best solution is a threaded mounting sensor, but for periodic measurement magnetic base is considered a practical alternative procedure.

Caution:



The measurement is only available by setting an **ACCELEROMETER** type sensor. If the VELOMITOR sensor is used, an error message will inform the user about the impossibility to perform the measurement with that type of sensor.

“CBA” – measurement screen

The measurement page supplies a series of information, organized as shown in the figure:



1. “CBA” value detected

Measurement of a “CBA” value

Select the CBA mode from the main page of the instrument by pressing the key **OK**.

At the first access to the function after switching on the instrument, if no measurement has been performed yet, an alarm reminds to connect the sensors before making the measurement.

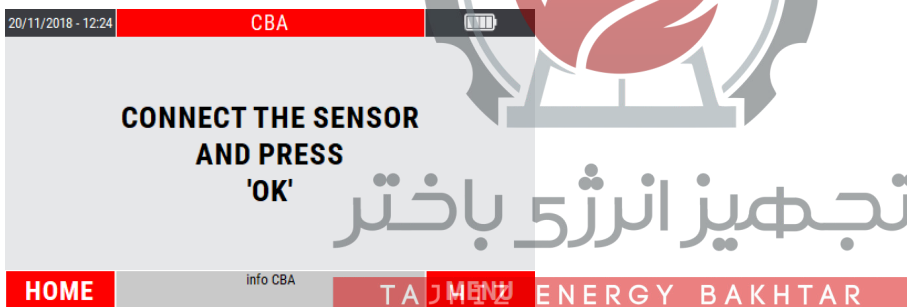

Press **OK** to start the measurement; the instrument acquires continuously, press again **OK** to freeze the acquisition.

MENU function

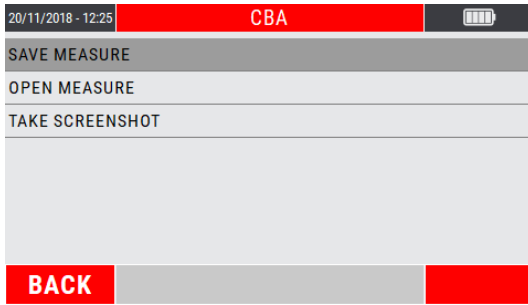

Access to the menu using the key . The following functionalities are available here:

- **Save measure**

Allows the data saving in a determined project of the detected measurement (see **Function "Save measure" 2-4**).

- **Open measure**

Allows the opening of a certain measure previously acquired through the CBA mode and saved in a specific project (see **Function "Open measure" 2-5**).

- **Take Screenshot**

Allows to "capture" the image on the screen by saving it as a *.png* file (see **Function "Take screenshot" 2-7**).





تجهیز انرژی باختر

TAJHIZ ENERGY BAKHTAR

“TACHO” mode

Before proceeding with more in-depth analysis, operators may sometimes need to detect the rotation velocity of one or more of the shafts with a high degree of precision.

The N130 instrument has a precise tachometer function, capable of measuring rotation speed of up to 250.000 RPM.

“TACHO” – measurement screen

The measurement page supplies a series of information, organized as shown in the figure:

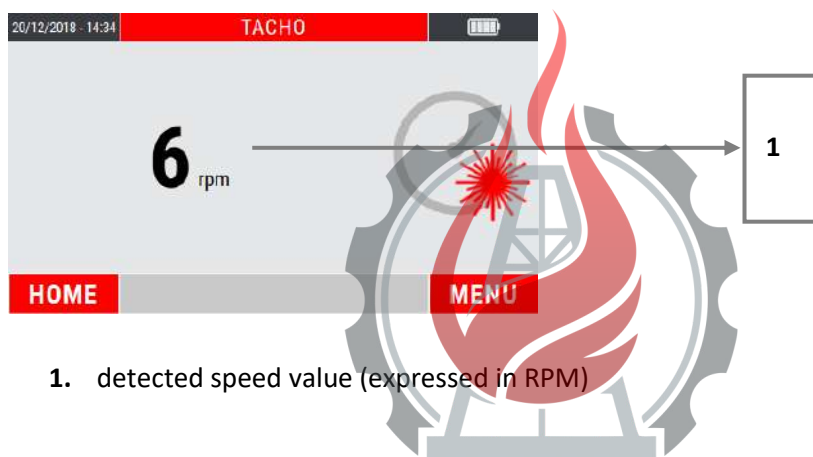

1. detected speed value (expressed in RPM)

Note:

Before to use the TACHO mode, apply a suitable reflecting sticker on the rotating body as a point of reference (0°).



Connect the **photocell (optional)** to the N130 instrument and position it at a distance of between 60 and 1000 mm from the rotating body.

For the photocell setup see “**Appendix D – Photocell for instruments CEMB Nx30**”.

Caution:

Take great care when positioning the photocell: as the rotating body requires manual intervention, make sure that it is still and cannot be started up accidentally.



If the rotating body cannot be rotated by hand when positioning the photocell, it should be positioned in points in which the LEDs are visible without having to get too close to the moving bodies.

Measurement of a “TACHO” value

Select the TACHO mode from the main page of the instrument by pressing the key .

At the first access to the function after switching on the instrument, if no measurement has been performed yet, an alarm reminds to connect the sensors before making the measurement.



Press  to start the measurement; the instrument acquires continuously, press again  to freeze the acquisition.

MENU function

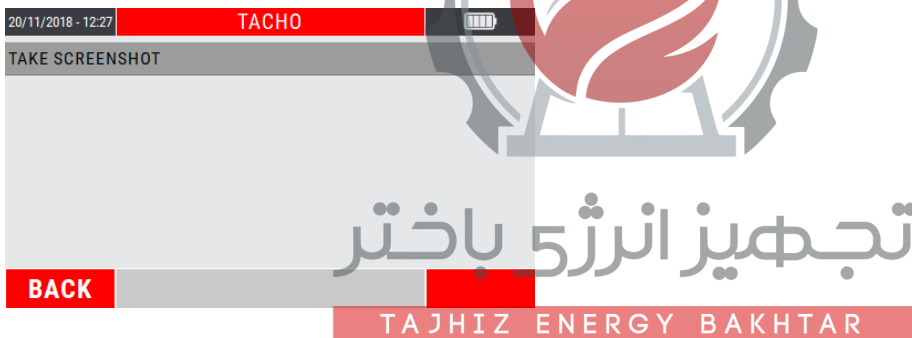

Access to the menu using the key . The following functionalities are available here:

- **Take Screenshot**

Allows to "capture" the image on the screen by saving it as a *.png* file (see **Function "Take screenshot" 2-7**).

Appendix A

Technical data

General Characteristics	
Dimensions:	195(W) x 120(L) x 35(H) mm
Weight:	490 gr
Display:	<ul style="list-style-type: none">• 4.3" colour LED-backlit TFT LCD• high visibility with direct exposure to sunlight• resolution 480x272 pixel
Keyboard:	<ul style="list-style-type: none">• no.8 embossed keys, included no.2 function keys• improved tactile feedback when used with gloves
Environmental protection class:	IP54
Power-up time:	15 seconds
Measure availability time:	3 seconds
User interface:	multiple language (Italian, English, German, Spanish, French, Chinese, Russian)
Bandwidth:	10 KHz
Frequency max.:	1; 2,5; 5; 10 KHz
FFT resolution:	400; 800; 1600; 3200 lines
Internal memory capacity:	14,8 GB (expandable up to 128 GB)
Environmental Characteristics	
Temperature:	from -20°C to +70°C
Air humidity:	from 0 to 95% without condensate
Power Supply	
Battery life:	more than 8 hours based on typical use of the instrument
Charging time:	<ul style="list-style-type: none">• 2,5 hours from completely flat battery to 80% charge• 4 hours from completely flat battery to 100% charge
Battery type:	rechargeable Lithium battery – 3100 mAh
Battery charger:	<ul style="list-style-type: none">• input 100÷240Vac – 50/60Hz• output 12Vdc, 1,5A• “multiplug” type
Inputs	
Available inputs:	<ul style="list-style-type: none">• no.1 channel for IEPE sensors, ACCELEROMETER and VELOMITOR (with a specify cable pluggable on a BNC for read any dynamic signal max 10V PkPk)• no.1 channel for PHOTOCCELL• no.1 MicroUSB 2.0 port for data transfer• no.1 jack plug for battery charger
Connectable sensors:	<ul style="list-style-type: none">• ACCELEROMETER “IEPE” – editable sensitivity• VELOMITOR “IEPE” – editable sensitivity• generic with 10V PkPk max signal (only with special BNC connecting cable)• PHOTOCCELL (30÷120.000 RPM)

Carrying case	
Dimensions:	approx. 370(W) x 300(L) x 115(H) mm
Weight complete of Standard accessories:	approx. 1800 gr
Measurement types	
Measure mode:	<ul style="list-style-type: none"> • effective value [RMS] • Peak value [Pk] • Peak-to-Peak value [PkPk]
Measure units:	<ul style="list-style-type: none"> • acceleration - [g] • velocity - [mm/s] or [inch/s] • displacement - [μm] or [mils] • frequency - [Hz] or [CPM] • rotation speed - [RPM]



تجهیز انرژی باختر

TAJHIZ ENERGY BAKHTAR

Evaluation criteria

ISO 10816-3 Mechanical vibration - Evaluation of machine vibration by measurements on non-rotating parts - Part 3: industrial machines with nominal power above 15 kW and nominal speeds between 120 r/min and 15 000 r/min when measured in situ.

Introduction

ISO 10816-3 constitutes the basic document that describes the general requirements for evaluation of vibration in different types of machinery when the vibration measurements are made on non-rotating parts. It provides specific guidance to assess the severity of the vibration measured on bearings, bearing supports or industrial machine casings when the measurements are made in situ.

Measurement points

Normally, the measurements should be made on the visible parts of the machine which are usually accessible. Due care should be taken so that the measurements are reasonably representative of vibration of the bearing seat and do not lead to any local resonance or amplification. The vibration measurement positions and directions must be such as to offer adequate sensitivity to the dynamic forces of the machine. Generally, this requires two orthogonal radial measurement positions on each bearing cap or support as illustrated in Figures 1 and 2.

تجهیز انرژی باکhtar
TAJHIZ ENERGY BAKHTAR

The sensors can be arranged in any angular position on the bearing housings or supports. For horizontally mounted machines, it is generally preferable to arrange the sensors in vertical and horizontal position. For inclined or vertically mounted machines, the position that gives the maximum vibration reading, normally in the direction of the flexible shaft, must be one of those used. In some cases, measurement in axial direction is also advisable.

On a bearing cap or support, only one sensor can be used instead of the more usual pair of orthogonal sensors if it is known that this sensor provides sufficient information on the machine vibration amplitude. However, precautions must be taken when evaluating vibration using only one sensor at the level of a measurement plane, as you risk it not being oriented to provide a reasonable approximation of the maximum value on this plane.

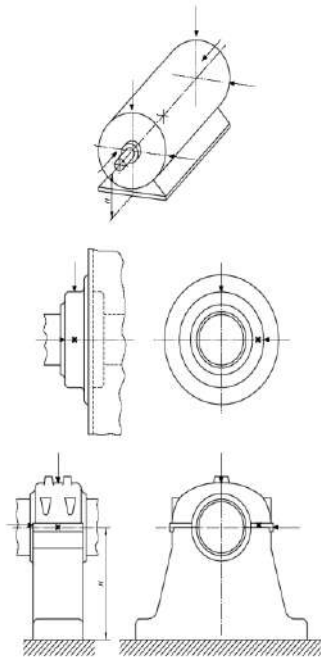

Figure 1 Measurement points

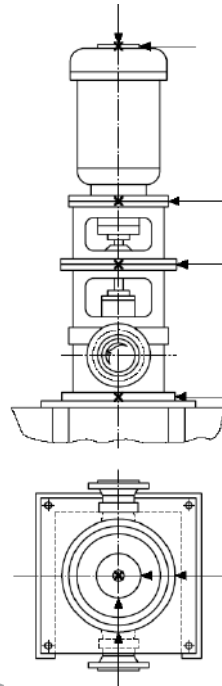

Figure 2 Measurement points for vertical machine units

Classification according to machine type, nominal power or shaft height

Significant differences in design, type of bearings and type of support structures require a division into different machine groups (as regards the shaft height, see ISO 496). The machines in the 4 groups below may have a horizontal, vertical or inclined shaft and may be mounted on rigid or flexible supports.

تجھیز انرژي باختر

Group 1: Large machines with nominal power above 300 kW or electrical machines with shaft heights $H \geq 315$ mm.

These machines normally have sleeve bearings. The range of operating or nominal speeds is relatively broad with ranges from 120 r/min to 15 000 r/min.

Group 2: Medium-sized machines with nominal power above 15 kW up to and including 300 kW or electrical machines with shaft heights from 160 mm up to ≥ 315 mm.

These machines normally have rolling bearings and an operating speed above 600 rpm

Group 3: Pumps with fin rotors and separate motor (mixed or axial flow centrifugal pumps) with nominal power above 15 kW.

The machines in this group may have sleeve or rolling bearings.

Group 4: Pumps with fin rotors and incorporated motor (mixed or axial flow centrifugal pumps) with nominal power above 15 kW.

The machines in this group normally have sleeve or rolling bearings.

Classification according to support flexibility

The flexibility of the support unit in the specified directions is classified considering two possibilities:

- rigid supports
- flexible supports

These support conditions are determined by the ratio between the flexibility of the machine and that of its foundation. If the natural lowest frequency of the combined machine-support system in the measuring direction is greater by at least 25% than the main excitation frequency (in most cases, this is the rotation frequency) in this direction, the support system may be considered rigid. All other support systems may be considered flexible.

Typical examples: large and medium-sized electrical motors, mainly with low speeds, have rigid supports, while turbo generators and compressors with power above 10 MW and vertical machine units normally have flexible supports.

In certain cases, a support may be rigid in one direction and flexible in the other. For example, the natural lowest frequency in vertical direction may be well above the main excitation frequency, while the natural frequency in horizontal direction may be considerably lower. Such a system would be rigid on the vertical but flexible on the horizontal plane. In these cases, the vibration should be evaluated according to the classification of the support that corresponds to the measuring direction.

TAJHIZ ENERGY BAKHTAR

If the machine-support system class cannot easily be determined from drawings or calculated, it can be determined with tests.

Evaluation zones

The following evaluation zones are defined to allow qualitative vibration evaluation of a given machine and to provide guidelines for any action to be taken.

Zone A: the vibration of newly commissioned machines normally falls within this zone;

Zone B: machines with vibration within this zone are normally considered acceptable for unrestricted long-term operation;

Zone C: machines with vibration within this zone are normally considered unsatisfactory for long-term continuous operation. Generally, the machine may be operated for a limited period in this condition until a suitable opportunity arises for remedial action;

Zone D: vibration values within this zone are normally considered to be of sufficient severity to cause damage to the machine.

The numerical values specified are not intended to serve as the only basis for acceptance specifications, but should be agreed upon between the machine manufacturer and the customer. Nevertheless, the vibration limits for the zone boundaries provide guidelines for ensuring that gross deficiencies or unrealistic requirements are avoided. In certain cases, particular construction solutions may be adopted for a given machine, which would require adopting different values (greater or smaller) for the zone limits. In these cases, the machine manufacturer generally needs to explain the reasons and, in particular, confirm that the machine would not be damaged by operation at higher vibration values.

Evaluation zone limits

Table A.1 Classification of the vibration severity zones for Group 1 machines: Large machines with nominal power above 300 kW but not greater than 50 MW or electrical machines with shaft heights $H \geq 315$ mm

Support class	Zone limit	Effective velocity mm/s
Rigid	A/B	2,3
	B/C	4,5
	C/D	7,1
Flessixible	A/B	3,5
	B/C	7,1
	C/D	11,0

Table A.2

Classification of the vibration severity zones for Group 2 machines: Medium-sized machines with nominal power above 15kW up to and including 300 kW or electrical machines with shaft heights from 160 mm up to ≤ 315 mm

Support class	Zone limit	Effective velocity mm/s
Rigid	A/B	1,4
	B/C	2,8
	C/D	4,5
Flessixible	A/B	2,3
	B/C	4,5
	C/D	7,1

Table A.3

Classification of the vibration severity zones for Group 3 machines: Pumps with fin rotors and separate motor (mixed or axial flow centrifugal pumps) with nominal power above 15 kW

Support class	Zone limit	Effective velocity mm/s
Rigid	A/B	2,3
	B/C	4,5
	C/D	7,1
Flessixible	A/B	3,5
	B/C	7,1
	C/D	11,0

تجهیز انرژی باکhtar
TAJHIZ ENERGY BAKHTAR

Table A.4

Classification of the vibration severity zones for Group 4 machines: Pumps with fin rotors and incorporated motor (mixed or axial flow centrifugal pumps) with nominal power above 15 kW

Support class	Zone limit	Effective velocity mm/s
Rigid	A/B	1,4
	B/C	2,8
	C/D	4,5
Flessixible	A/B	2,3
	B/C	4,5
	C/D	7,1



تجهیز انرژی باختر

TAJHIZ ENERGY BAKHTAR

A rapid guide to interpreting a spectrum

TYPICAL CASES OF MACHINE VIBRATIONS

1. PRELIMINARY RAPID GUIDE

Measured values during control

f = vibration frequency [cycles/min] or [Hz]

s = shaft amplitude [μm]

v = vibration speed [mm/s]

a = vibration acceleration [g]

n = piece rotation speed [rpm]

Frequency data	Causes	Notes
1) $f = n$	Unbalances in rotating bodies.	Intensity proportional to unbalance, mainly in the radial direction, increases with speed.
	Rotor inflection.	Axial vibrations sometimes sensitive.
	Resonance in rotating bodies.	Critical speed near n with very high intensity.
	Roller bearings mounted with eccentricity.	Recommend balancing the rotor on its own bearings.
	Misalignments.	Considerable axial vibration also present, greater than 50% of the transverse vibration; also frequent cases of $f = 2n, 3n$.
	Eccentricity in pulleys, gears, etc...	When the rotation axis does not coincide with the geometric axis.
	Irregular magnetic field in electrical machines.	Vibration disappears when power is cut off.
	Belt length an exact multiple of the pulley circumference.	Stroboscope can be used to block belts and pulleys at the same time.
	Gear with defective tooth.	An unbalance vibration often also intervenes.
Alternating forces.	Second and third harmonic present.	
2) $f \cong n$ with knocking	Mechanical unbalance defect superimposed on irregular magnetic field.	In asynchronous motors, the knocking is due to running.
3) $f \cong (0,40 \div 0,45) n$	Defective lubrication in sleeve bearings.	For high n , above the 1° critical level. Check with stroboscope. Precision journal movement (oil whirl).
	Faulty roller bearing cage.	Check for harmonics.
4) $f = \frac{1}{2} n$	Mechanical weakness in rotor.	This is a sub-harmonic, often present but hardly ever important.
	Sleeve bearing shells loose.	$f = 2n, 3n, 4n$ and semi-harmonics also often present.
	Mechanical yield.	

Frequency data	Causes	Notes
5) $f = 2n$	Misalignment. Mechanical looseness.	There is strong axial vibration. Loose bolts, excessive play in the mobile parts and bearings, cracks and breaks in the structure: there are upper grade sub-harmonics.
6) f is an exact multiple of n	Roller bearings misaligned or forced in their housings. Defective gears. Misalignments with excessive axial play. Rotors with blades (pumps, fans).	Frequency = $n \times$ number of spheres or rollers. Check with stroboscope. $f = z n$ ($z =$ number of defective teeth). Because of general wear, teeth badly made if $z =$ total number of teeth. Often caused by mechanical looseness. $f = n \times$ number of blades (or channels)
7) f is much greater than n , not an exact multiple	Damaged roller bearings. Excessive wear on sleeve bearings. Belts too tight. Multiple belts not homogeneous. Low load gears. Rotors with blades for fluid management (cavitation, reflux, etc.).	Unstable frequency, intensity and phase. Axial vibration. Completely or locally defective lubrication. Audible screech. Characteristic audible screech. Run between the belts. Teeth knock together because of insufficient load; unstable vibration. Unstable frequency and intensity. $f = n \times$ number of blades \times number of channels. Frequent axial vibration.
8) $f =$ natural frequency of other parts	Excessive play on sleeve bearings. Belts disturbed by vibrations from other parts.	Oil whip caused by vibrations in other parts. Check with stroboscope. Examples: eccentric or unbalanced pulleys, misalignments, rotor unbalances.
9) f unstable with knocking	Multiple belts not homogeneous. Belts with multiple joints.	Unstable intensity.
10) $f = n_c$ $n \neq n_c$	($n_c =$ critical speed of shaft) Roller bearings. ($n_r =$ mains frequency) Electric motors, generators	For rotors above the 1st critical speed. Harmonics also present.
12) $f = f_c < n$ or $f = 2 f_c$	Belt with defective elasticity in one area.	f_c is the belt frequency. $f_c = \pi D n / l$ ($D =$ pulley diameter; $l =$ belt length).

Considerable axial vibrations, more than 10% of the transverse vibration, may be caused typically by:

- shaft inflection, especially in electrical motors;
- distorted foundations;
- defective thrust bearings;
- wear in stuffing box seals, etc.;
- elliptic eccentricity in the electric motor rotor;
- rotor side rubbing;
- forces deriving from tubing;
- defective radial bearings;
- defective coupling;
- defective belts.

2. TYPICAL SPECTRA OF VIBRATIONS RELATED TO THE MOST COMMON DEFECTS



Note:

The spectra are in an indicative graphic form. The N130 equipment produces a different form of graph.

The following are the spectra of typical vibrations, caused by the most common defects found in practical experience.



Note:

CPM = shaft rotation speed in RPM.

1. UNBALANCE

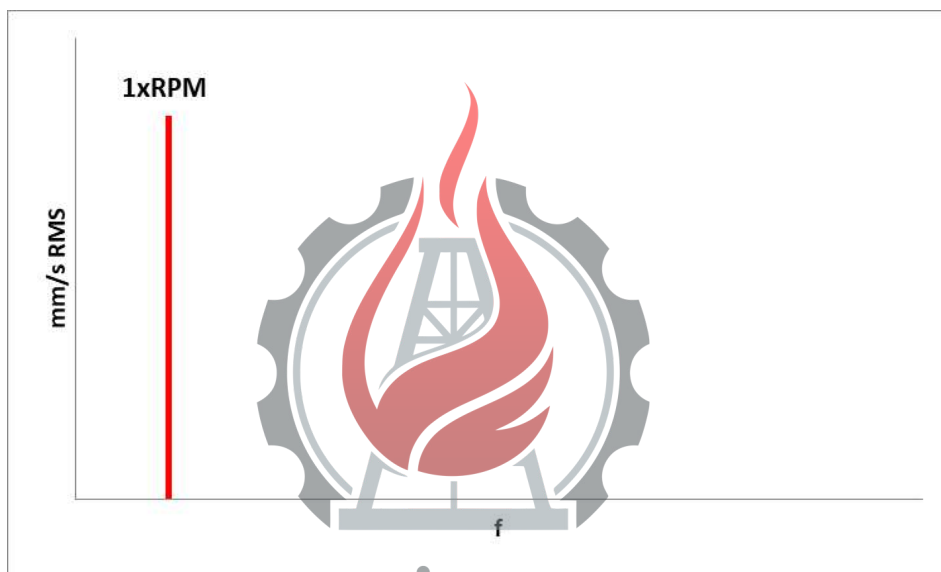

تجهیز انرژی باکتر
2. MISALIGNMENT

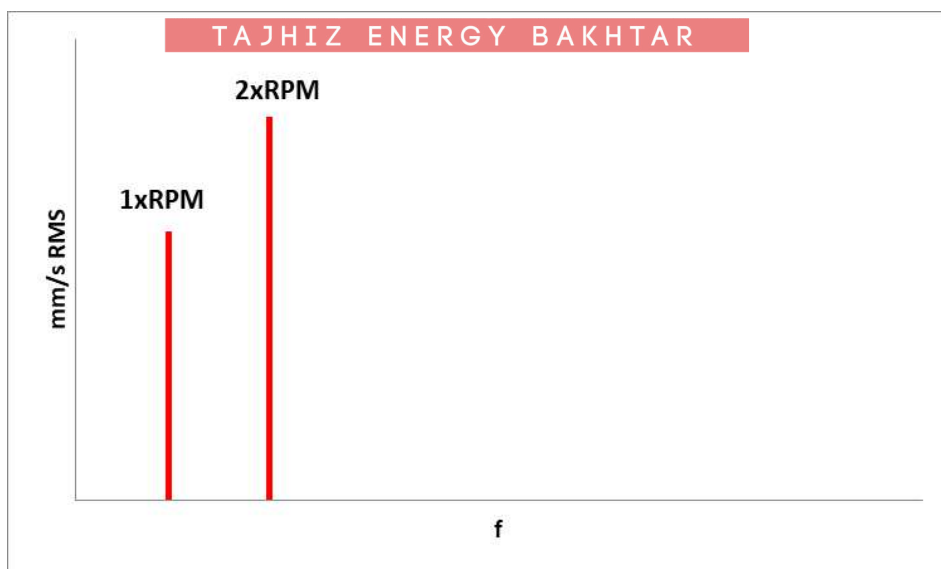

3. MECHANICAL LOOSENESS

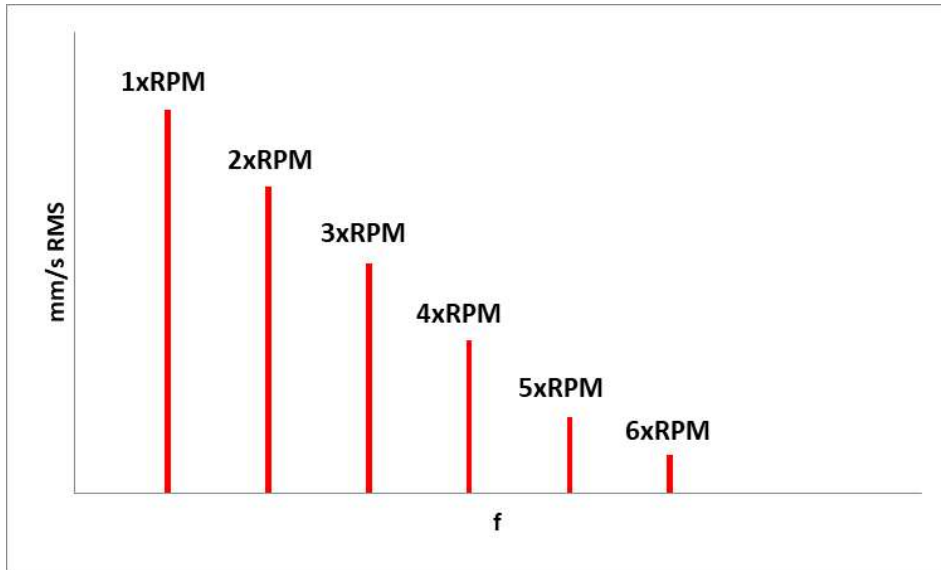

4. BELT



5. GEARS

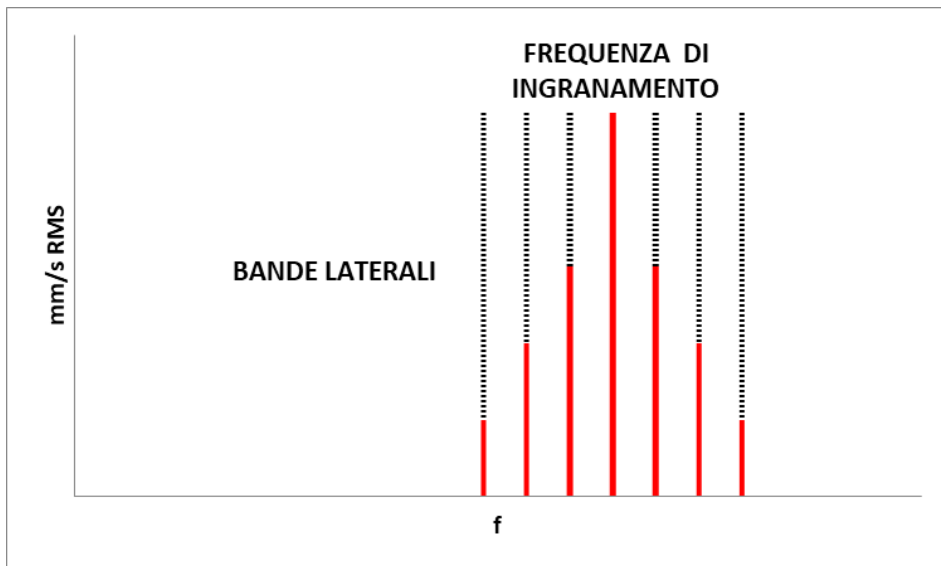

6. SLEEVE BEARINGS

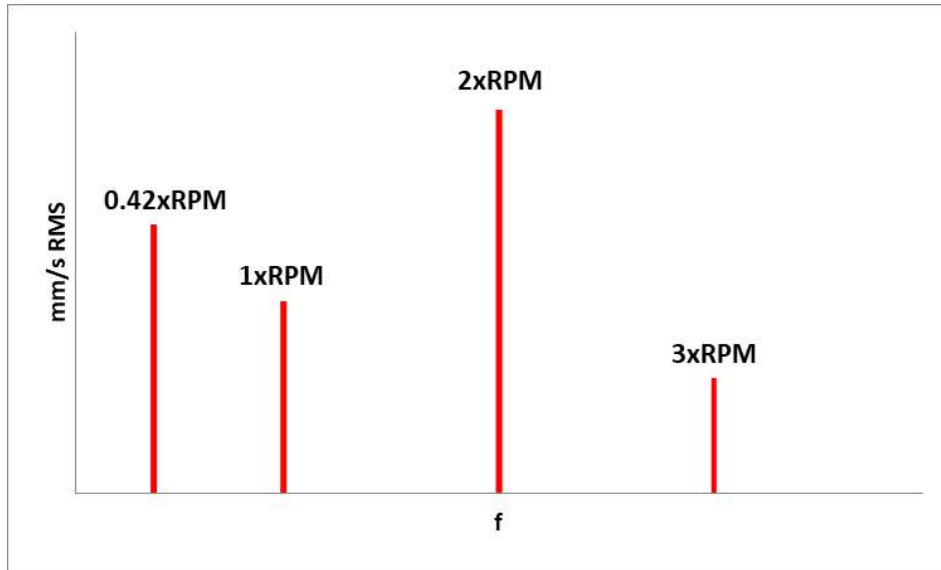

7. ROLLER BEARINGS

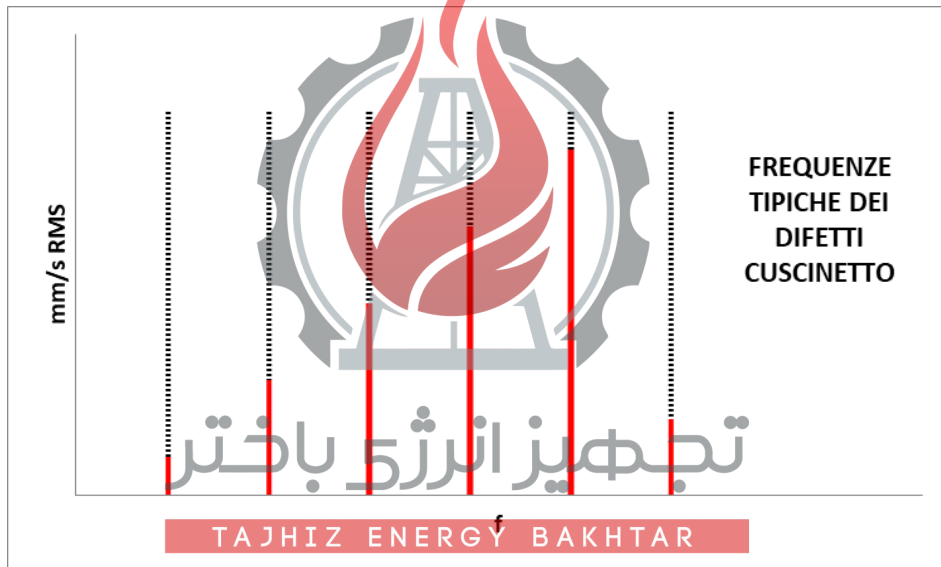

8. ELECTRIC MOTORS

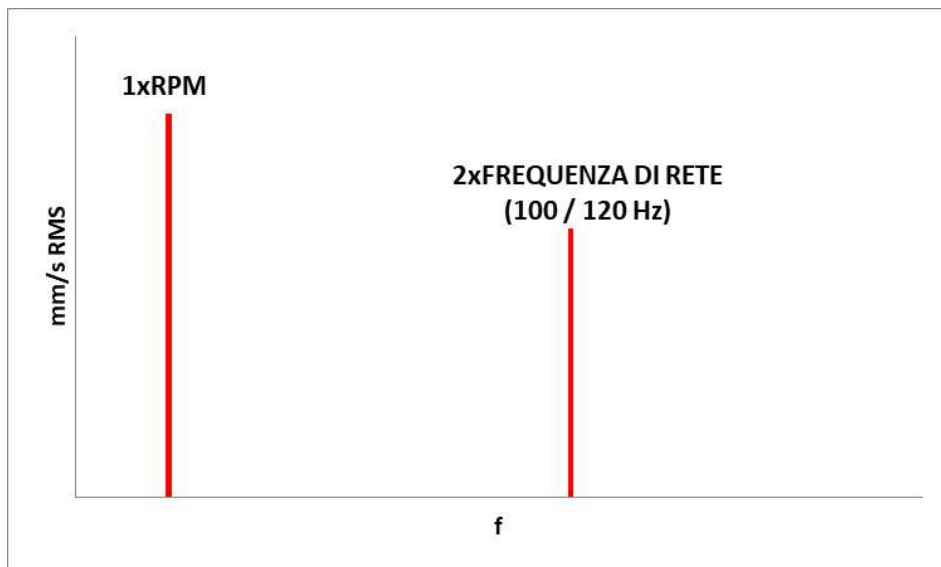

3. FORMULAE FOR CALCULATING TYPICAL BEARING DEFECT FREQUENCIES

The most common case:

a - fixed external ring (rotating internal ring)

$$FTF = \frac{S}{2} \cdot \left[1 - \left(\frac{BD}{PD} \right) \cdot \cos\Theta \right] \quad \text{Housing frequency}$$

$$BPFO = \frac{S}{2} \cdot N \cdot \left[1 - \left(\frac{BD}{PD} \right) \cdot \cos\Theta \right] \quad \text{Defect on outer track}$$

$$BPFI = \frac{S}{2} \cdot N \cdot \left[1 + \left(\frac{BD}{PD} \right) \cdot \cos\Theta \right] \quad \text{Defect on inner track}$$

$$BSP = \frac{S}{2} \cdot \left(\frac{PD}{BD} \right) \cdot \left[1 - \left(\left(\frac{BD}{PD} \right) \cdot \cos\Theta \right)^2 \right] \quad \text{Defect on roller/ball}$$

b - rotating external ring (fixed internal ring)

$$FTF = \frac{S}{2} \cdot \left[1 + \left(\frac{BD}{PD} \right) \cdot \cos\Theta \right] \quad \text{Housing frequency}$$

$$BPFO = \frac{S}{2} \cdot N \cdot \left[1 - \left(\frac{BD}{PD} \right) \cdot \cos\Theta \right] \quad \text{Defect on outer track}$$

$$BPFI = \frac{S}{2} \cdot N \cdot \left[1 + \left(\frac{BD}{PD} \right) \cdot \cos\Theta \right] \quad \text{Defect on inner track}$$

$$BSP = \frac{S}{2} \cdot \left(\frac{PD}{BD} \right) \cdot \left[1 - \left(\left(\frac{BD}{PD} \right) \cdot \cos\Theta \right)^2 \right] \quad \text{Defect on roller/ball}$$

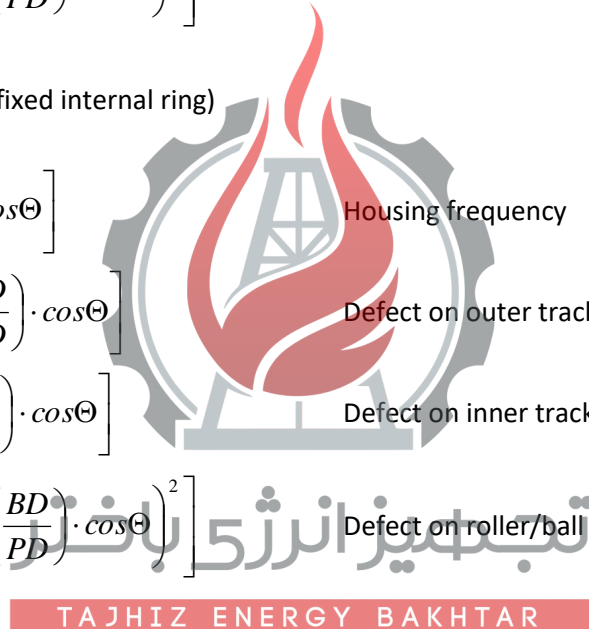

The frequencies of bearings can be calculated if we know:

- S = number of shaft rpm
- PD = primitive diameter BD = ball/roller diameter
- N = number of balls/rollers
- Θ = angle of contact

Approximate calculation formulae (± 20%)

- FTF = 0.4 x S (a) or 0.6 x S (b)
- BPFO = 0.4 x N x S (a) or (b)
- BPFI = 0.6 x N x S (a) or (b)
- BSP = 0.23 x N x S (N < 10) (a) or (b)
- = 0.18 x N x S (N ≥ 10) (a) or (b)

Photocell for instruments CEMB Nx30

Specifications:

CEMB complete code:	920X30025
Distance from target:	60 ÷ 1000 mm
Current consumption:	30mA nominal

Spare parts:

CEMB sensor only, code:	800625310
CEMB cable 2 meters only, code:	962020718

Connections:

CONNECTOR	PINOUT (Yellow connector)
	1 - +24 VDC 5 - TACHO IN 8 - GROUND + SHIELDING

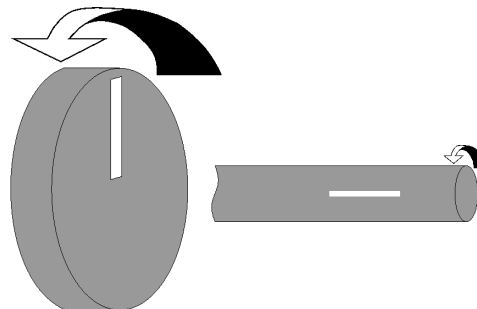

TAJHIZ ENERGY BAKHTAR

Reflector position on rotor or shaft:

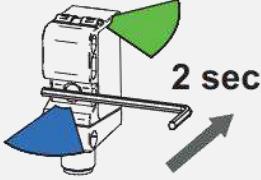
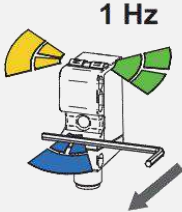
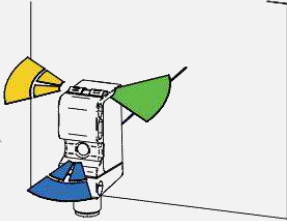
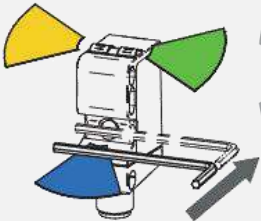

1. Stick a piece of reflective tape on the rotor;
2. It must be at least twice the size of the laser spot;
3. The laser beam should hit the centre of the reflector.

Photocell calibration:

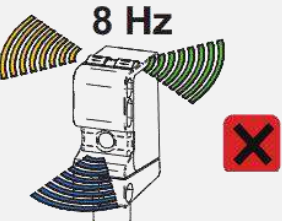
STEP	DESCRIPTION	
1		<p>With photocell power-on (green LED on), touch the back of the photocell with a tool (e.g. screwdriver) for 2 seconds</p>
2		<p>LEDs green and yellow flashing (frequency 1 Hz)</p>
3		<p>Align photocell spot to the target(reflective tape stucked on the shaft/impeller)</p>
4		<p>Touch quickly the back of the photocell with a tool, to confirm target acquisition</p>
5		<p>Calibration successful</p>
6		<p>Calibration failed</p>

Note:



It is also possible not use a reflector. If there is a difference in color between the marker used and the shaft/impeller, can be used other types of markers (colored adhesive tape, matte paint marker, etc.).



Caution:

If there is more than one target the speed detected will not be the correct one.

The JSON format

The N130 uses JSON files to store the different measures.

JSON (*JavaScript Object Notation*) is an open standard format for data exchange. For people it is easy to read and write, while for machines it is easy to generate and analyze.

JSON is a text format completely independent of the programming language.

Libraries and functions for parsing and JSON data generation are available in all popular languages. This feature makes JSON an ideal language for data exchange.

JSON is a self-documenting format that describes both the structure and names of the fields, as well as their value. It has a rigid syntax that allows an implementation of simple, efficient and consistent parsing algorithms.

JSON is based on two structures:

- A set of name/value pairs
- An ordered list of values

These are universal data structures. Virtually all modern programming languages support them in both forms.

In JSON, they take these forms:

An object is an unordered series of names/values. An object begins with { (left brace) and ends with } (right brace). Each name is followed by : (colon) and the name/value pair is separated by , (comma).

object

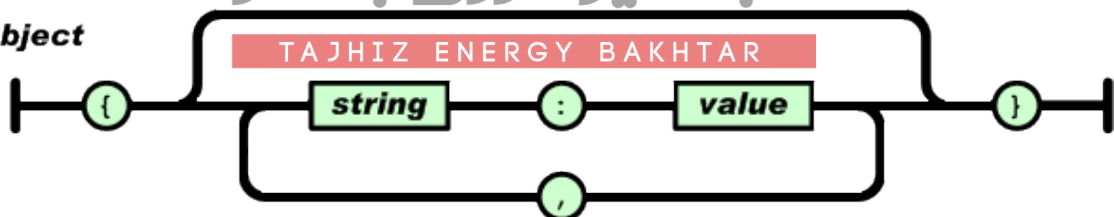

An array is an ordered collection of values. An array begins with [(left bracket) and ends with] (right bracket). Values are separated by , (comma).

array

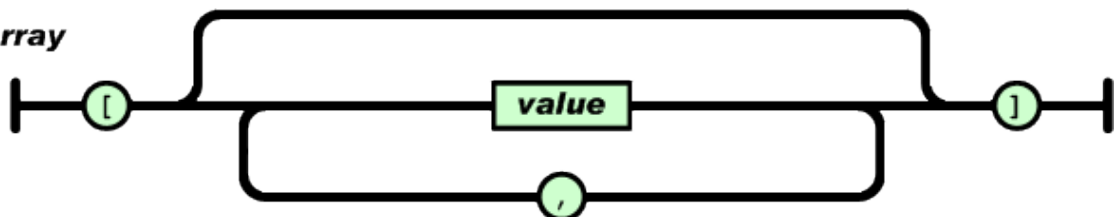

A value can be a string in quotes, or a number, either true or false, or an object or an array. These structures can be nested.

value

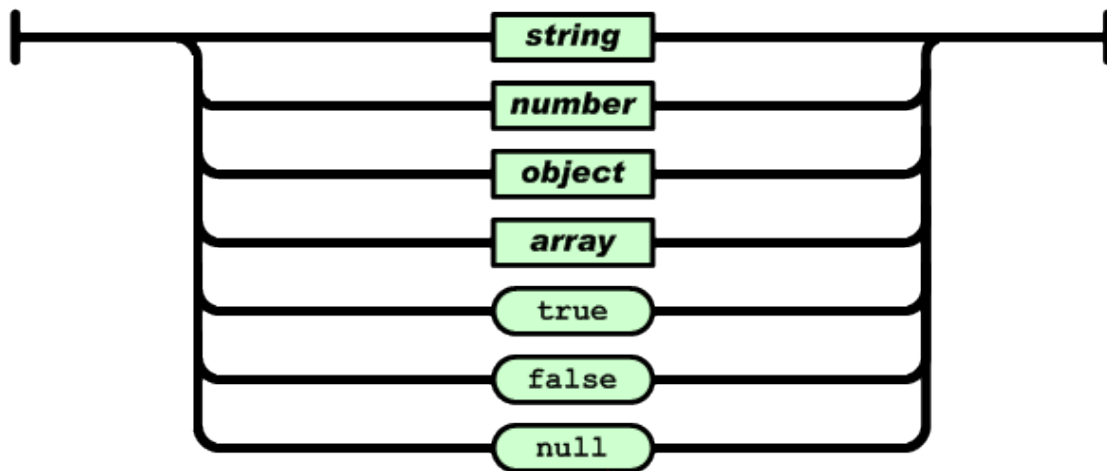

Using these basic structures, JSON can represent the most complex data structures: records, lists, trees ...

The use of a standard and open format like JSON makes it extremely easy to create macros or applications to extract the necessary information and use them according to your needs.

MS Excel allows to import JSON files directly from the version "2016". For previous versions can be used Power Queries or VBA macros.

Detailed information on the JSON format are available online.

As an example:

- <https://json.org/>
- ECMA-404 The JSON Data Interchange Standard
[<http://www.ecma-international.org/publications/files/ECMA-ST/ECMA-404.pdf>]
- JSON file online reader **TAJHIZ ENERGY BAKHTAR**
<http://jsonviewer.stack.hu/>

N130 measurement archive

The N130 device organizes the measurement archive in projects.

Each project is saved in a different JSON file, whose name is the name chosen for the project.

All projects are available on the device, within the folder <N130\archive>.

Each file is organized with a tree structure:

- Measurement point (Support number / direction) - for example "point 3x"
 - Array of measures
 - Measurement

All measurements have common information:

- An object called "measureType" whose value is a string corresponding to the measure type
 - OVERALL measurement saved in the Vibrometer function
 - SYNC 1x measurement saved in the Vibrometer 1xRPM function
 - FFT measurement saved in the FFT function
 - SMART ANALYSIS measurement saved in the Smart Analysis function
 - CBA measurement saved in the CBA bearing analysis function
- An object called "dateTime" whose value is a string with the measurement acquisition date and time (in ISO 8601 format)

When necessary, each measurement also contains the settings with which it was acquired. The various measures are saved with the following structure.

OVERALL

```
{
  "main peak":{
    "amplitude":{
      "value":9.7,
      "unit":"mm/s",
      "unit mode":"RMS"
    },
    "frequency":{
      "value":46.5,
      "unit":"Hz"
    }
  },
  "overall":{
    "value":3.6,
    "unit":"mm/s",
    "unit mode":"RMS"
  },
  "dateTime":"2018-12-17T12:23:42",
  "setup":{
    "max frequency":{
      "value":1000.0,
      "unit":"Hz"
    },
    "high-pass frequency":{
      "value":0.0,
      "unit":"Hz"
    },
    "No. of lines":400,
    "No. of averages":2
  },
  "measureType":"OVERALL"
}
```



تجهیز انرژی باختر

TAJHIZ ENERGY BAKHTAR

SYNC 1x

```
{
  "amplitude":{
    "value":9.6,
    "unit":"mm/s",
    "unit mode":"RMS"
  },
  "frequency":{
    "value":1650.0,
    "unit":"rpm"
  },
  "phase":39.7,
  "dateTime":"2018-12-19T11:06:29",
  "setup":{
    "max frequency":{
      "value":1000.0,
      "unit":"Hz"
    },
    "high-pass frequency":{
      "value":10.0,
      "unit":"Hz"
    },
    "No. of lines":400,
    "No. of averages":2
  },
  "measureType":"SYNC 1x"
}
```



FFT

```
{
  "overall":{
    "value":1.5,
    "unit":"mm/s",
    "unit mode":"RMS"
  },
  "spectrum":{
    "lines":[0.0,0.0, 0.0, ... 0.0],
    "unit":"mm/s",
    "unit mode":"RMS",
    "df":{
      "value":2.5,
      "unit":"Hz"
    }
  },
  "peaks":[
    {
      "amplitude":{
        "value":9.167,
        "unit":"mm/s",
        "unit mode":"RMS"
      },
    },
  ],
}
```

تجهیز انرژی باختر

TAJHIZ ENERGY BAKHTAR

```

    "frequency":{
      "value":45.3125,
      "unit":"Hz"
    }
  },
  ...
  {
    "amplitude":{
      "value":0.78,
      "unit":"mm/s",
      "unit mode":"RMS"
    },
    "frequency":{
      "value":252.5,
      "unit":"Hz"
    }
  }
],
"dateTime":"2018-12-20T09:40:27",
"setup":{
  "max frequency":{
    "value":1000.0,
    "unit":"Hz"
  },
  "high-pass frequency":{
    "value":10.0,
    "unit":"Hz"
  },
  "No. of lines":400,
  "No. of averages":2
},
"measureType":"FFT"
}

```



تجهیز انرژی باختر

TAJHIZ ENERGY BAKHTAR

SMART ANALYSIS

```

{
  "vibration":{
    "overall":{
      "value":4.9,
      "unit":"mm/s",
      "unit mode":"RMS"
    },
    "components":{
      "unbalance":3.44,
      "misalignment":1.088,
      "looseness":0.549,
      "other":2.362,
      "unit":"mm/s",
      "unit mode":"RMS"
    },
    "speed":{
      "value":340,

```

```
    "unit": "rpm"
  }
},
"machine condition": "Unlimited long-term operation",
"machine type": "LARGE MACHINES - POWER >300KW",
"foundation": "flexible",
"dateTime": "2018-12-20T09:07:58",
"speed reference": "photocell",
"measureType": "SMART ANALYSIS"
}
```

CBA

```
{
  "overall": {
    "value": 7.0,
    "unit": "gE",
    "unit mode": "CBA"
  },
  "dateTime": "2018-12-21T16:26:57",
  "measureType": "CBA"
}
```



تجهیز انرژی باختر

TAJHIZ ENERGY BAKHTAR